

TECHNICAL INFORMATION GUIDE

Standard Cure Dual Color DC1000E Coating Resins

Fast Cure Dual Color DC1000E Coating Resins

- **Overview**
- **Technical Data Sheets**
- **Picote Brush Coating™ Certified Installer Training**
- **ASTM Testing**
- **NSF 61.5 Certification**
- **Chemical Resistance**
- **SDS Sheets**



TABLE OF CONTENTS

TOPIC	PAGE
GENERAL INFORMATION AND PRODUCT DESCRIPTION	3
TECHNICAL DATA SHEET	4
PICOTE BRUSH COATING™ CERTIFIED INSTALLER TRAINING	7
NSF 61.5 CERTIFICATION	8
ASTM TESTING	9
CHEMICAL RESISTANCE TESTING	15
SDS (SAFETY DATA SHEETS) - US	17
SDS (SAFETY DATA SHEETS) - EUROPE	48

To watch practical demonstration videos, take a course, or to download an electronic copy of these Instructions, please visit www.picoteinstitute.com. Please note that videos and courses are not intended as a replacement or alternative to this operating and safety manual, but only as an additional learning tool.

GENERAL INFORMATION / PRODUCT OVERVIEW

PRODUCT DESCRIPTION:

This product has been created to renovate drains, sewers, water pipes, electrical conduits, heat and a/c ducts and more in concrete, PVC, fiberglass, clay, copper, cast iron, ductile iron, and steel pipes by brush casting a coating. The specially formulated coating resin forms a corrosion resistant or semi-structural repair inside the original pipe (depending on # of coats applied) that is a tested, safe and environmentally friendly product. The new pipe is corrosion resistant, anti-static, wear-resistant and non-corrosive. Thanks to a high breaking stretch, it also withstands shocks and bending.

USES/BASIC METHODOLOGY:

- Extend the life span of the original pipe: The resin can be used to prolong the life of an existing pipe. Clean the pipe well. Apply 2 or more (0.5-0.7mm/coat) layers of the DC1000E resin.
- The new slick inner surface will increase the flow inside the pipe minimizing the risk of blockages.
- Create a new semi-structural pipe: Apply multiple coats of the resin (use design calculator based on pipe diameter found in the manual or later in this document) to form a seamless new pipe with a 2-4mm wall thickness depending on the pipe diameter. Estimated 30-50 year design life when using Semi-Structural Design Specifications based on pipe diameter.

BENEFITS FOR CONTRACTORS:

Extend the service life of a pipe, stop corrosion, create a new pipe, "patch" on top of CIPP liners and fortify connections*. Apply to small areas or all drains in multi-story buildings. The Picote Coating™ System is affordable, practical and easily fits in tight places.

BENEFITS FOR PROPERTY OWNERS:

Customers can stay at home or keep business open during drain renovation. A greener alternative eliminating the need to destroy existing walls, gardens or sidewalks, the no-dig solution reduces waste produced at job sites. Interruptions to traffic are also minimized. All materials used are non-toxic.

HOW LONG WILL THE PIPE BE OUT OF SERVICE?:

Dry to touch in 3 hours with ambient cure.

Return to Service/Light Wear: 4 hours.

Final Hardness: 24 hours.

Full service can be restored 4 hours after last coat has been applied (24hrs for potable)

TYPES OF PIPE:

Suitable for concrete, PVC, fiberglass, clay, copper, cast iron, ductile iron, and steel pipes. Preparation of the coating surface is dependent on the material of the pipe. Please see corresponding Picote Operation & Safety Manual.

OPERATIONAL SETUP:

The Picote Brush Coating™ System and DC1000E Resin is powered by the Picote Millers. The Mini or Maxi Coating Pump is conveniently set on the top of the Miller. Picote Millers can also be used for pipe preparation, drain cleaning and reinstatements on lateral connections. The system is practical and easy to keep clean.

**Ensure that materials are compatible and the surface is properly prepared.*

TECHNICAL DATA SHEET

GENERAL DESCRIPTION	DC1000E 100% Solids Epoxy Dual component epoxy used to rehabilitate concrete, PVC, fiberglass, clay, cast iron and ductile iron pipes. Creating a monolithic corrosion barrier or semi-structural repair of decayed and damaged pipes. Designed exclusively for the Picote Brush Coating™ System.
NUMBER OF COMPONENTS	2
MIX RATIO	2:1 mix ratio by volume in pre-packaged cartridges.
PACKAGE SIZES	6x900ml: 2-part cartridges with 6 cartridges in each case.
NET WEIGHT	11.7 lbs/Gallon (1.2kg/Litre).
PIPE DIAMETER RANGE	1¼-12" (DN32-300) pipes.
WORKING METHOD	Coating applied with brush.
COLOR USAGE	Contrasting colors (White & Gray or White & Blue) between coats.
APPLICATION EQUIPMENT	Picote Brush Coating™ System using Mini or Maxi Coating Pumps and Picote Millers.
LEVELING	Product is self leveling.
GAS EMISSIONS	No harmful VOCs released during mixing or after hardening (VOC free).
DRY CONTENT/SOLIDS	100% solids (no solvents).
FLASH POINT	392°F (200°C).
GLOSS	Semi-gloss.
THINNER	Not used.
SHRINKAGE	100% Solids, does not shrink.
HUMIDITY	Hydrophobic, repels water.
UV RESISTANCE	Direct sunlight can alter color of coating.
STATIC/CONDUCTIVITY	Electrical insulating material, does not conduct electricity and is anti-static.
SURFACE PREPARATION	All surfaces to be coated must be dry and clean, free from oil, grease, debris and other contaminants. Concrete: must be jetted and cleaned removing any loose concrete. Steel/Ductile Iron: Near-White SSPC-SP10/NACE 2. Acceptable methods: sand blast, chain flail, or Picote Smart Cutter™ and Side Grinding Panels Stainless Steel: Nace No. 1/SSPC SP-5 White Metal Blast cleaning is needed and is beyond the capability of Picote cleaning tools. White metal blast cleaning is to be used to clean unpainted or painted steel surfaces prior to applying high-performance protective coating or lining systems. SSPC-SP 5/NACE No. 1 removes all visible oil, grease, dust, dirt, mill scale, rust, coating, oxides, corrosion products, and any other foreign matter on the surface.
POT LIFE	Mixed resin about 25 min @70°F (21°C).
RATE OF COVERAGE	See Picote Resin Calculator (www.picoteinstitute.com) Average expected application per coat: Approximately 27 mils (.7mm) Minimum expected application per coat= 10 mils (0.3mm) Maximum expected application per coat= 20-40 mils (0.5-1mm)

TECHNICAL DATA SHEET

NUMBER OF COATS

Number of coats required is dependent on pipe diameter and rehabilitation goal
Estimated 30-50 year design life when using Semi-Structural Design Specifications.
Resistance to High Pressure Water Jetting:

- Minimum 4 coats need to be applied.
- Maximum Jetting Pressure: 2600 PSI (180 Bar).
- Corrosion Resistance: After cleaning metal pipes, corrosion will come back even quicker without coating

Pipe Diameter	# of Coats for Corrosion Resistance	# of Coats for Semi Structural
1¼" (DN32)	2	2
1½" (DN40)	2	2
2" (DN50)	2	2
3" (DN70)	2	2
4" (DN100)	2	3 to 4
6" (DN150)	2 to 3	4 to 5
8" (DN200)	3 to 4	5 to 6
9" (DN225)	4 to 5	6 to 7
10" (DN250)	4 to 5	7 to 8
12" (DN300)	5 to 6	8 to 9

RESIN CALCULATOR:

The Picote DC1000E Resin Calculator is an Excel spreadsheet that can be downloaded from the Picote Institute online learning platform at picoteinstitute.com. It calculates project resin usage based on pipe diameter, number of coats, and length of repair.

HARDENING/CURE TIME

Recoat: 3 hours @70°F (21°C).
Restore flow: 4 hours (24hrs for potable water projects) @70°F (21°C).
Final Cure: 24 hours @70°F (21°C).

RECOAT

Can be recoated within 12 hours without additional pipe preparation.
After 12 hours must be abraded with Picote Smart Cutter™ Side Grinding Panels.

TEMPERATURES

Installation: 50-140°F (10-60°C).
Storage: Room Temperature 60-95°F (15.5-29°C) .
Finished Product:

- Max: up to 180°F (82°C) in most commercial hot water applications.
- Min: 40°F (4.5°C). in standard water applications.

NSF/ANSI 61.5 TESTING:

NSF/ANSI 61.5 Certification:

Product certified to NSF/ANSI 372 conforms to the requirements or "Lead Free" plumbing products as defined by California, Vermont, Maryland and Louisiana. Standard: NSF/ANSI 61 Section 5 - 2016. Models: DC1000E, Color: White. Picote's 100% Solids Epoxy Resin, DC1000E, is certified for potable water pipes (DN100) 4" and above. Final coat must be in White.

TECHNICAL DATA SHEET

MECHANICAL TESTING:

ASTM Testing:

Tensile Strength	D638-14	2,979 PSI
Compression Strength	D695-15	9,570 PSI
Flexural Modulus	D790-15e2	430 KSI
Flexural Strength	D790-14e2	6,080 PSI
Adhesive Strength	D4541	Substrate failure
Adhesion Strength Metal:	803 PSI with static mixing tip	
Adhesion Strength Concrete:	100% concrete breakage when pulled away.	

SHELF-LIFE

Unopened: 24 months from date of manufacture when stored according to recommended conditions.
Opened: up to 6 weeks.

STORAGE TEMPERATURE

60-85°F (15.5-29°C)

CLEAN UP

Clean brush and pump hose fittings using acetone. Dispose of delivery & pump hose.
REFER TO SAFETY DATA SHEET FOR SAFETY AND HEALTH INFORMATION.

INDUSTRIAL SAFETY

Ready-measured product must not be in contact with skin (it adheres)

SAFETY DATA SHEET (SDS)

Available via QR code on resin packaging as well as online at www.picoteinstitute.com in Picote DC1000E Resin Technical document.

SHIPPING

The two part resin is packaged in sealed tubes. Suggested storage at room temperature and in accordance with the guidelines in Technical Data Sheet.

TECHNICAL ENQUIRIES

Ryan Boldan, Global Learning Solutions Dir. 1 (864) 940-0088
ryan@picotesolutions.com

Richard Swan, Director of Client Technical Services 44 (0) 782 722 3237
richard@picotesolutions.com

PICOTE BRUSH COATING™ CERTIFIED INSTALLER TRAINING

TRAINING CENTRES:

- Phoenix, Arizona, USA
- Porvoo, Finland
- Sandhurst, England, UK



Picote Certified Installer Training for Picote Brush Coating™ is highly recommended to get the most out of your investment and provide the highest quality finished results

For Picote Brush Coating™ Certified Installer Training you will receive a Picote ID Card for completion (UK only), which can be used for the tendering process and on site.

Certificates are awarded for all certification trainings.

Visit our website at www.picotegroup.com or contact us at training@picotesolutions.com to find out about course offerings, pricing, and scheduling.

10 YEAR WARRANTY*

When using the Picote Brush Coating™ System as an option for semi-structural pipe rehabilitation you are providing a solution that can last 30-50 years. When you successfully complete Picote Certified Installer Training you will be able to offer a 10 year warranty on the Picote DC1000E Epoxy Resin when you meet the outlined criteria. This provides assurance for the end-user as well as an advantage when you tender for work.

*Terms & conditions apply, ask for details.

NSF 61.5 CERTIFICATION



ALS Group USA, Corp.

3337 Michelson Drive, Suite CN750, Irvine, CA 92612

Certified Product Listing

For:

Drinking Water System Components – Health Effects

Company:

Picote Solutions, Inc.
20810 SE 18th Place
Sammamish, WA 98075, United States

Plant Location:

Sandy, UT, United States

Standards:

NSF/ANSI/CAN 61 - 2020

Certificate:

Issued Date: 03/29/2017

Material/Product:

Coatings

Contact Temperature:

23 ± 2°C

Models:

DC1000E

A handwritten signature in black ink, appearing to read 'Zhang'.



Product certified to NSF/ANSI/CAN 372 conforms to the requirements for "Lead Free" plumbing products as defined by California, Vermont, Maryland and Louisiana state laws and by section 1417 of the US SDWA.

ALS Group's Product Certification Listing directory contains the most current certified product(s) and supersedes all printed copies of the listings.

Page 1/2

NSF 61.5 CERTIFICATION



ALS Group USA, Corp.

3337 Michelson Drive, Suite CN750, Irvine, CA 92612

Material Characteristics:

Minimum pipe diameter (inches): 4

Maximum pipe surface area/volume ratio (sq in/L): 61

Minimum tank size (gallons): 50

Maximum tank surface area/volume ratio (sq in/L): 16.8

Maximum dry film thickness per coat (mils): 125

Number of coats: 1

Is additional coating required (e.g. top coat, primer, intermediate coat)? (Y/N): No

Total cure time and temperature: 4 days @ 70°F

Shortest cure time between coats or layers: 2 hours

Final cure time: 4 days @ 70°F

Mix ratio: 2:1

Colors: White

Is this paint/coating system intended to be applied to a pipe? (Y/N): Yes

(1) Certified for use on a new pipe? (Y/N): Yes

(2) Certified for use on a pipe intended for immediate return to service? (Y/N): No

Additional comments:

Flushing or preparation instruction prior to use:

a) Flushing Time: General Flush at 15 minutes

b) Temperature of Flush: 23 ± 2 °C



Product certified to NSF/ANSI/CAN 372 conforms to the requirements for "Lead Free" plumbing products as defined by California, Vermont, Maryland and Louisiana state laws and by section 1417 of the US SDWA.

ALS Group's Product Certification Listing directory contains the most current certified product(s) and supersedes all printed copies of the listings.

Page 2/2

ASTM TESTING

TESTED PRODUCT: Picote Dual Color Epoxy

TEST 1

A total of four tests were performed including:

1. Tensile Strength
2. Compression Strength
3. Flexural Modulus
4. Coating Pull Off Strength.

TEST 1: ASTM D638-14 "Tensile Strength"

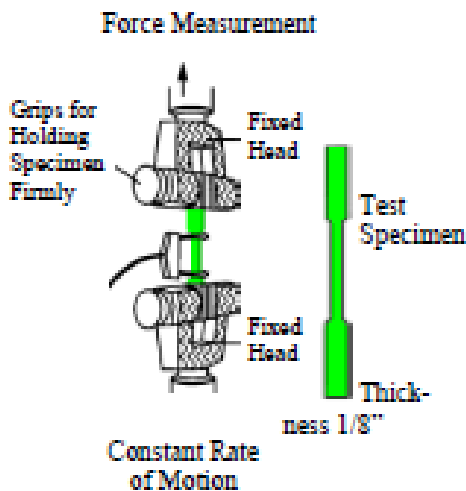

A piece of finished product, with a maximum thickness of .125-inches, is machined into a dog-bone shape. Each end of the test specimen is placed in opposite facing clamps which then attempt to pull it apart.

The PSI that it takes to break the specimen is calculated as "Tensile Strength at the Break". The "Tensile Elongation at the Break" is an additional measurement that shows how much the product stretches during this test. The "Tensile Modulus" is a measure taken to test rigidity. All of these measurements make up the "Tensile Strength" test. The D638-14 test would simulate separating pipe joints and the effect that would have on the product in question.

TEST 1 RESULTS: Picote Epoxy Coating Tensile Test

Test Method:	ASTM D638-14
Test Conditions:	23±2°C, 50±10% R.H.
Conditioning:	40+ hours, 23±2°C, 50±10% R.H.
Preparation:	Machined from sample sent by client
Specimen:	Type I tensile bars (2-inch gage length)
Cross Head Speed:	0.2-inches per minute

Sample	Replicate	Width (inches)	Thickness (inches)	Tensile Strength at Break (psi)	Tensile Elongation at Break (%)	Tensile Modulus at Young's (ksi)
P/N Picote Dual Coat 1000E*						
		0.5117	0.2209	2970	0.62	586
Requirement				n/a	n/a	n/a

*Picote Dual Color Epoxy 2110001001

ASTM TESTING

TESTED PRODUCT: Picote Dual Color Epoxy

TEST 2

A total of four tests were performed including:

1. Tensile Strength
2. Compression Strength
3. Flexural Modulus
4. Coating Pull Off Strength.

TEST 2: D695-15 "Compression Strength"



A sample of the product at approximately .25-inches is laid flat and a machine pushes down on the specimen until it begins to compress. The PSI it requires to shear the sample is its "Compression Strength". The amount it swells when the pressure is applied is also measured.

This test will show how well the product can sustain loads. Please note: This test does not measure the Compression Strength of the cylinder that is created by the product inside the pipe.

TEST 2 RESULTS: Picote's Epoxy Coating Compressive Test

Test Method:	ASTM D695-15
Test Conditions:	23±2°C, 50±10% R.H.
Conditioning:	40+ hours, 23±2°C, 50±10% R.H.
Preparation:	Machined from sample sent by client
Specimen:	Prism (1.0-inch length)
Cross Head Speed:	0.05 inches per minute

Sample	Replicate	Width (inches)	Thickness (inches)	Compressive Strength at Yield (PSI)
P/N Picote Dual Coat 1000E*				
		0.5260	0.2302	9570
Requirement				n/a

*Picote Dual Color Epoxy 2110001001

ASTM TESTING

TESTED PRODUCT: Picote Dual Color Epoxy

TEST 3

A total of four tests were performed including:

1. Tensile Strength
2. Compression Strength
3. Flexural Modulus
4. Coating Pull Off Strength.

TEST 3: D790-15e2 "Flexural Modulus"

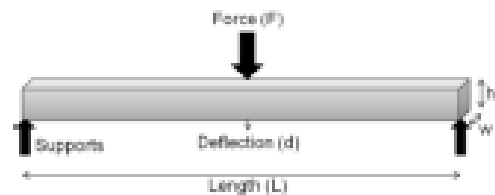

This test is used to measure the horizontal strength of the material. Supports are placed under the sample at each end, and then a piston drives down at the center. The force to drive down and the amount of deflection are measured to come up with the specimen's "Flexural Modulus".

This test would simulate areas in a coated pipe that are being subjected to uneven stress.

TEST 3 RESULTS: Picote's Epoxy Coating Flexural Test

Test Method:	ASTM D790-15e2, Procedure A
Test Conditions:	23±2°C, 50±10% R.H.
Conditioning:	40+ hours, 23±2°C, 50±10% R.H.
Preparation:	Machined from sample sent by client
Support Span:	3.641 inches
Cross Head Speed:	0.090 inches per minute

Sample	Replicate	Width (inches)	Depth	Flexural Strength at Break (PSI)	Flexural Modulus (KSI)
P/N Picote Dual Coat 1000E*					
	2	0.5117	0.2142	6080	418
Requirement					

*Picote Dual Color Epoxy 2110001001

ASTM TESTING

TESTED PRODUCT: Picote Dual Color Epoxy

TEST 4

A total of four tests were performed including:

1. Tensile Strength
2. Compression Strength
3. Flexural Modulus
4. Coating Pull Off Strength.

TEST 4: D4541-09 "Coating Pull Off Strength"

In this test, a dolly is glued to the epoxy and allowed to cure. The sample is then cored using a hole saw. A device with a piston is attached that pulls away from the substrate until it breaks.



This test can look for two different outcomes depending upon the substrate used. When a brick or concrete substrate is used in a real-world application, it is testing whether or not that substrate breaks before the coating (product) does. If steel were to be used, however, the coating will always break before the substrate, so the PSI is also measured at the time of the break.

The D4541-09 test simulates a pipe (that has been coated with the product) breaking, failing, or becoming compromised in any way and how well the material would hold up and stay adhered under those circumstances.

TEST 4 RESULTS: Picote's Epoxy Coating Pull-off Strength Test

Test Method:	ASTM D4541-09
Test Conditions:	23±5°C, 50±35% R.H.
Conditioning:	As sent by client
Preparation:	Coating as sent by client.
Specimen:	Loading fixture glued to coating
Instrument:	Fixed alignment test modified to use a tensile tester
Cross Head Speed:	0.2 inches per minute

ASTM TESTING

TEST 4 RESULTS: Picote's Epoxy Coating Pull-off Strength Test continued

Sample	Replicate	Loading Fixture Diameter (inches)	Pull-Off Strength (psi)	Failure Mode
P/N Picote Dual Coat 1000E – Brick Substrate				
		0.500	>700	1-10% Coating Failure
P/N Picote Dual Coat 1000E – Metal Substrate				
		0.500	>803	1-10% Coating Failure
P/N Picote Dual Coat 1000E – Concrete Substrate				
		0.500	>798	0.1-1% Coating Failure
Requirement			n/a	

*Picote Dual Color Epoxy 2110001001

CHEMICAL RESISTANCE

CHEMICAL RESISTANCE DC1000E

Acetic Acid (20%)	Excellent	Ferric Chloride	Excellent (temperature < 72oF, 22oC)
Acetone	Not Recommended	Ferric Sulfate	Excellent (temperature < 72oF, 22oC)
Acetylene	Excellent	Ferrous Chloride	Excellent (temperature < 72oF, 22oC)
Alcohol - Ethyl	Excellent (temperature < 120oF, 50oC)	Ferrous Sulfate	Excellent (temperature < 72oF, 22oC)
Alcohol - Isopropyl	Excellent	Fluorine gas	Note Recommended
Alcohol - Methyl	Good (temperature < 72oF, 22oC)	Fluosilicic acid	Fair
Aluminum Chloride	Excellent (temperature < 72oF, 22oC)	Formaldehyde, 40%	Excellent (temperature < 72oF, 22oC)
Aluminum Fluoride	Good (temperature < 72oF, 22oC)	Formic Acid	Fair (temperature < 72oF, 22oC)
Aluminum Hydroxide	Good (temperature < 72oF, 22oC)	Freon	Excellent
Aluminum Sulfate	Excellent (temperature < 72oF, 22oC)	Gasoline	Excellent
Amines	Excellent (temperature < 72oF, 22oC)	Glucose	Good
Ammonia - Liquid	Excellent (temperature < 72oF, 22oC)	Glycerine	Excellent
Ammonia 10%	Excellent (temperature < 72oF, 22oC)	Heptane	Excellent
Ammonium Carbonate	Excellent (temperature < 72oF, 22oC)	Hexane	Good
Ammonium Chloride	Excellent (temperature < 72oF, 22oC)	Hydraulic Fluid	Excellent
Ammonium Hydroxide	Excellent (temperature < 72oF, 22oC)	Hydrobromic Acid, 100%	Not Recommended
Ammonium Nitrate	Excellent (temperature < 72oF, 22oC)	Hydrochloric acid, 20%	Good (temperature < 72oF, 22oC)
Ammonium Phosphate	Excellent (temperature < 72oF, 22oC)	Hydrocyanic Acid	Excellent
Ammonium Sulfate	Excellent (temperature < 72oF, 22oC)	Hydrofluoric Acid, 75%	Good (temperature < 72oF, 22oC)
Amyl acetate	Excellent (temperature < 72oF, 22oC)	Hydrogen Peroxide, 10%	Fair (temperature < 72oF, 22oC)
Aniline	Fair (temperature < 72oF, 22oC)	Hydrogen Sulfide	Excellent
Barium Carbonate	Excellent (temperature < 72oF, 22oC)	Jet Fuel	Excellent
Barium Chloride	Excellent (temperature < 72oF, 22oC)	Kerosene	Excellent
Barium Hydroxide	Excellent (temperature < 72oF, 22oC)	Lactic Acid	Good (temperature < 72oF, 22oC)
Barium Sulfate	Fair (temperature < 72oF, 22oC)	Lead acetate	Excellent
Barium Sulfide	Good (temperature < 72oF, 22oC)	Magnesium Carbonate	Excellent
Beer	Excellent (temperature < 72oF, 22oC)	Magnesium Chloride	Excellent
Benzol	Excellent (temperature < 72oF, 22oC)	Magnesium Hydroxide	Excellent
Borax	Excellent (temperature < 72oF, 22oC)	Magnesium Nitrate	Excellent
Boric acid	Excellent (temperature < 72oF, 22oC)	Magnesium Sulfate	Excellent
Bromine	Excellent (100 ppm)	Maleic Acid	Excellent
Butadiene gas	Excellent (temperature < 72oF, 22oC)	Mercury	Excellent
Butane gas	Excellent (temperature < 72oF, 22oC)	Methyl Ethyl Ketone	Fair (temperature < 72oF, 22oC)
Butyl acetate	Good (temperature < 72oF, 22oC)	Naphtha	Excellent
Butaric Acid	Fair (temperature < 72oF, 22oC)	Naphthalene	Excellent
Calcium Bisulfite	Excellent (temperature < 72oF, 22oC)	Nickel Chloride	Excellent
Calcium Carbonate	Excellent (temperature < 72oF, 22oC)	Nickel Sulfate	Excellent
Calcium Chloride	Excellent (temperature < 72oF, 22oC)	Nitric Acid 5%	Good
Calcium Hydroxide	Excellent (temperature < 72oF, 22oC)	Oil - Castor	Excellent
Calcium Hypochlorite	Excellent (temperature < 72oF, 22oC)	Oleic acid	Excellent
Calcium Sulfate	Excellent (temperature < 72oF, 22oC)	Oxalic Acid	Excellent
Carbon dioxide gas	Excellent (temperature < 72oF, 22oC)	Phenol	Good
Carbon Tetrachloride	Excellent (temperature < 72oF, 22oC)	Phosphoric Acid	Good
Carbonic Acid	Good (temperature < 72oF, 22oC)	Picric Acid	Excellent
Citric Acid	Excellent (temperature < 72oF, 22oC)	Potassium Bicarbonate	Excellent
Copper Chloride	Excellent	Potassium Bromide	Excellent
Copper Nitrate	Excellent (temperature < 72oF, 22oC)	Potassium Carbonate	Excellent
Dichloroethane	Good (temperature < 120oF, 50oC)	Potassium Chloride	Excellent
Diesel Fuel	Excellent (temperature < 72oF, 22oC)	Potassium Dichromate	Fair
Ethyl acetate	Fair (temperature < 72oF, 22oC)	Potassium Hydroxide	Excellent
Ethyl chloride	Excellent (temperature < 72oF, 22oC)	Potassium Nitrate	Excellent
Ethylene glycol	Fair (temperature < 72oF, 22oC)	Potassium Sulfate	Excellent
Fatty Acids	Excellent (temperature < 72oF, 22oC)	Propane, liquid	Excellent

CHEMICAL RESISTANCE

CHEMICAL RESISTANCE DC1000E

Propane, liquid	Excellent
Silver Nitrate	Excellent
Soaps/DETERGENT	Excellent
Sodium Acetate	Excellent
Sodium Bicarbonate	Excellent
Sodium Bisulfate	Excellent
Sodium Carbonate	Fair (temperature < 72oF, 22oC)
Sodium Chlorate	Excellent
Sodium Chloride	Excellent
Sodium Cyanide	Excellent
Sodium Fluoride	Excellent
Sodium Hydroxide, 10%	Excellent
Sodium Hydroxide, 50%	Good (temperature < 120oF, 50oC)
Sodium Hypochlorite, 100%	Not Recommended
Sodium Nitrate	Excellent
Sodium Silicate	Excellent
Sodium Sulfate	Excellent
Sodium Sulfite	Excellent
Sodium Thiosulfate	Excellent
Stannic Chloride	Excellent
Stearic Acid	Good
Sulfuric Acid, 20%	Excellent
Sulfuric Acid, 75-100%	Fair (temperature < 72oF, 22oC)
Sulfur Dioxide	Excellent (temperature < 72oF, 22oC)
Tannic Acid	Excellent
Tartaric Acid	Excellent
Toluene	Good (temperature < 72oF, 22oC)
Turpentine	Good
Urine	Excellent
Vinegar	Excellent
Water - Distilled	Excellent
Water - Fresh	Excellent
Water - Sea, Salt	Excellent
Xylene	Excellent
Zinc Chloride	Excellent

SDS SHEET - DC1000E CATALYST CLEAR (US)



SAFETY DATA SHEET

PICOTE BRUSH COATING™ EPOXY RESIN
DUAL COAT CATALYST (COLOR: CLEAR)

Revision date: 08-9-2023

SAFETY DATA SHEET

SECTION 1 . IDENTIFICATION

Product Name: DUAL COAT CATALYST Product Code: Picote DC1000 E CATALYST

PICOTE SOLUTIONS
20810 SE 18TH PL
SAMMAMISH, WA 98075

EMERGENCY CONTACT: INFOTRAC
DOMESTIC & CANADA: 800-535-5053
INTERNATIONAL: 352-323-3500

MANUFACTURER CONTACT:
PICOTE SOLUTIONS
RYAN BOLDAN
777 WEST PINNACLE PEAK RD, STE. B108
PHOENIX, AZ 85027
TEL: 1.480.622.8314

SECTION 2. HAZARD(S) IDENTIFICATION

GHS Ratings:

Acute Toxicity - Oral	4	Oral>300+<=2000mg/kg
Skin corrosion/irritation	2	Reversible adverse effects in dermal tissue, Draize score: >= 2.3 < 4.0 or persistent inflammation
Serious eye damage/eye irritation	1	Serious eye damage: Irreversible damage 21 days after exposure, Draize score: Corneal opacity >= 3, Iritis > 1.5
Skin sensitization	1	Skin sensitizer
Reproductive toxicity	2	Human or animal evidence possibly with other information

GHS Hazards

H302	Harmful if swallowed
H315	Causes skin irritation
H317	May cause an allergic skin reaction
H318	Causes serious eye damage
H361	Suspected of damaging fertility or the unborn child

GHS Precautions

P201	Obtain special instructions before use
P202	Do not handle until all safety precautions have been read and understood
P261	Avoid breathing dust/fume/gas/mist/vapours/spray
P264	Wash ... thoroughly after handling
P270	Do not eat, drink or smoke when using this product
P272	Contaminated work clothing should not be allowed out of the workplace
P280	Wear protective gloves/protective clothing/eye protection/face protection
P281	Use personal protective equipment as required
P310	Immediately call a POISON CENTER or doctor/physician
P321	Specific treatment (see ... on this label)
P330	Rinse mouth
P362	Take off contaminated clothing and wash before reuse
P363	Wash contaminated clothing before reuse
P301+P312	IF SWALLOWED: Call a POISON CENTER or doctor/physician if you feel unwell
P302+P352	IF ON SKIN: Wash with soap and water
P305+P351+P338	IF IN EYES: Rinse continuously with water for several minutes. Remove contact lenses if present and easy to do – continue rinsing
P308+P313	IF exposed or concerned: Get medical advice/attention
P332+P313	If skin irritation occurs: Get medical advice/attention
P333+P313	If skin irritation or a rash occurs: Get medical advice/attention
P405	Store locked up
P501	Dispose of contents/container to ...

SDS SHEET - DC1000E CATALYST CLEAR (US)

Signal Word: Danger



SECTION 3. COMPOSITION/INFORMATION ON INGREDIENTS

Chemical Name	CAS number	Weight Concentration %
Paratertiarybutylphenol	98-54-4	30.00% - 40.00%
Amine	1477-55-0	20.00% - 30.00%
1,5-Pentanediamine, 2 methyl	15520-10-2	20.00% - 30.00%
Silica	67762-90-7	5.00% - 10.00%
nonyl phenol	84852-15-3	1.00% - 5.00%

SECTION 4. FIRST AID MEASURES

If inhaled remove to fresh air. If breathing is difficult, give oxygen. Obtain medical advice if there are persistent symptoms.

Rinse immediately with plenty of water for at least 15 minutes. Ensure adequate flushing of the eyes by separating the eyelids with fingers. Remove contacts if present and easy to do. Continue Rinsing. Get medical attention, if irritation or symptoms of overexposure persists.

Immediately wash skin with soap and plenty of water.

If swallowed, call a physician immediately. Only induce vomiting at the instruction of a physician. Never give anything by mouth to an unconscious person.

SECTION 5. FIRE FIGHTING MEASURES

Flash Point: 134 C (273 F)

LEL: N/A

Not applicable

Foam, Carbon dioxide (CO₂) or dry chemical or water spray (water stream may be ineffective).

No information available

Not available

Firefighters, and others exposed, wear self-contained breathing apparatus.

SECTION 6. ACCIDENTAL RELEASE MEASURES

Stop leak. Dike or contain spill. Pump into slavage tanks and/or absorb with suitable material. Use sparkless shovel to remove material. Evacuate area and keep unnecessary and unprotected personnel from entering the spill area. Use appropriate containment and clean up immediately.

Corrosive. Avoid personal contact adn breathing vapor or mist. Stop leak, Dike and contain spill.Prevent spilled material from entering the ground, water and/or air by using appropriate containment methods.

SECTION 7. HANDLING and STORAGE

Avoid breathing vapor. Avoid contact with eyes, skin and clothing. Keep away from heat and flame. Keep container closed. Use with adequate ventilation. Wash thoroughly after handling.

Avoid exposure to heat, light, and air for prolonged periods of time. Store in a cool, dry well ventilated area away from sources of heat and incompatable materials. Eliminate all ignition materials and incompatible materials. Collect spill with non spark tools.

No information available.

SECTION 8.EXPOSURE CONTROLS, PERSONAL PROTECTION

PICOTE DC1000E RESIN SYSTEM

Version:
August 16, 2024

SDS SHEET - DC1000E CATALYST CLEAR (US)

Chemical Name / CAS No.	OSHA Exposure Limits	ACGIH Exposure Limits	Other Exposure Limits
Paratertiarybutylphenol 98-54-4	Not Established	Not Established	Not Established
Amine 1477-55-0	Not Established	0.1 mg/m3 Ceiling	NIOSH: 0.1 mg/m3 Ceiling
1,5-Pentanediamine, 2 methyl 15520-10-2	Not Established	Not Established	Not Established
Silica 67762-90-7	Not Established	Not Established	Not Established
nonyl phenol 84852-15-3	Not Established	Not Established	Not Established

Use appropriate engineering control such as process enclosures, local exhaust ventilation, or other engineering controls to control airborne levels below recommended exposure limits. Good general ventilation should be sufficient to control airborne levels. Where such systems are not effective wear suitable personal protective equipment, which performs satisfactory and meets OSHA or other recognized standards. Consult with local procedures for selection, training, and maintenance of the personal protective equipment. Always use adequate ventilation that comply with local regulations.

Eye/Face Protection: Wear appropriate protective glasses or splash goggles as described by 29 CFR 1910.133, OSHA eye and face protection regulation, or the European standard EN 166

Skin Protection: Chemical-resistant gloves and chemical goggles, face-shield and synthetic apron or coveralls should be used to prevent contact with eyes, skin or clothing.

Respiratory Protection: A NIOSH air purifying respirator with an organic vapor cartridge or canister may be permissible under certain circumstances where airborne concentrations are expected to exceed exposure limits. Protection provided by air purifying respirators is limited. Use a positive pressure air supplied respirator if there is any potential for an uncontrolled release, exposure levels are not known or any other circumstance where air purifying respirator may not provide adequate protection.

SECTION 9. PHYSICAL and CHEMICAL PROPERTIES

Boiling Point 247 °C	Specific Gravity (SG) 0.987
Lbs VOC/Gallon Less Water 0.00	Lbs VOC/Gallon Less 0.00 Exempt
% VOL by Volume 0.00	

SECTION 10. STABILITY and REACTIVITY

Stable, Hazardous polymerization will not occur. Will react with Epoxy Resins especially at elevated temperatures

STABLE

Epoxy Resins under uncontrolled conditions. Mineral acids. Organic acid, oxidizers, Reacts with metals until reacted with epoxy. Nitrogen oxides and other toxic and acidic gasses when burned.

None known

Hazardous polymerization will not occur.

SECTION 11. TOXICOLOGICAL INFORMATION

Mixture Toxicity

Oral Toxicity LD50: 1,897mg/kg
Dermal Toxicity LD50: 3,190mg/kg
Inhalation Toxicity LC50: 2,878mg/L

Component Toxicity

98-54-4 Paratertiarybutylphenol

SDS SHEET - DC1000E CATALYST CLEAR (US)

1477-55-0	Oral LD50: 3,250 µL/kg (Rat) Dermal LD50: 2,318 mg/kg (Rabbit) Amine Oral LD50: 660 mg/kg (Rat) Dermal LD50: 2 g/kg (Rabbit) Inhalation LC50: 700 ppm (Rat)
84852-15-3	nonyl phenol Oral LD50: 1,300 mg/kg (Rat) Dermal LD50: 2,031 mg/kg (Rabbit)

Eyes: Irritant to the eyes. Corrosive to Eyes
Skin: Irritant to the skin. Corrosive to Skin
Inhalation: Irritant to respiratory tract. Prolonged or excessive inhalation may cause respiratory tract irritation.
Sensitization: Skin sensitization in humans.

Eyes Kidneys Liver Skin Respiratory System

Effects of Overexposure

<u>CAS Number</u>	<u>Description</u>	<u>% Weight</u>	<u>Carcinogen Rating</u>
-------------------	--------------------	-----------------	--------------------------

Avoid breathing vapors

Oral: N.D.A.
Dermal: N.D.A.
Inhalation: N.D.A.

SECTION 12. ECOLOGICAL INFORMATION

No ecotoxicity data was found for the product

Component Ecotoxicity

Paratertiarybutylphenol	96 Hr LC50 Pimephales promelas: 4.71 - 5.62 mg/L [flow-through]; 96 Hr LC50 Cyprinus carpio: 6.9 mg/L [static] 48 Hr EC50 Daphnia magna: 3.9 mg/L; 48 Hr EC50 Daphnia magna: 3.4 - 4.5 mg/L [Static] 72 Hr EC50 Desmodesmus subspicatus: 11.2 mg/L
nonyl phenol	96 Hr LC50 Pimephales promelas: 0.135 mg/L [flow-through]; 96 Hr LC50 Lepomis macrochirus: 0.1351 mg/L [flow-through] 48 Hr EC50 Daphnia magna: 0.14 mg/L 96 Hr EC50 Pseudokirchneriella subcapitata: 0.36 - 0.48 mg/L [static]; 72 Hr EC50 Pseudokirchneriella subcapitata: 0.16 - 0.72 mg/L [static]; 72 Hr EC50 Desmodesmus subspicatus: 1.3 mg/L

SECTION 13. DISPOSAL INFORMATION

Dispose of in accordance with applicable local/municipal, state/provincial and federal regulations.

SECTION 14. TRANSPORT INFORMATION

UN2735 Amines, Liquid, corrosive, n.o.s. (Benzene-1,3-Dimethanamine,1,5-Pentanediamine, 2-Mthyl).
DOT Hazad Class 8
DOT Packaging Class II

<u>Agency</u>	<u>Proper Shipping Name</u>	<u>UN Number</u>	<u>Packing Group</u>	<u>Hazard Class</u>
---------------	-----------------------------	------------------	----------------------	---------------------

SECTION 15. REGULATORY INFORMATION

OSHA:29 CFR 1910.1200 Hazardous Chemical "Irritant", Sensitizer
TSCA: Ingredients listed
SARA III: Sec311 & 312 Immediate Health Hazard; Sec313 Chemicals above de minimus level: None
CA PROP. 65 NOTICE WARNING:

SDS SHEET - DC1000E CATALYST CLEAR (US)

CANADIAN REGULATORY INFORMATION

WHMIS; Hazard Classification: D2B Skin Sensitizer. Refer to SDS for specific warnings

WHMIS Symbols: Stylized T.

WHMIS Trade Secret Registry Numbers: None

Hazardous Products Act Information: This product SDS contains ingredients which are Controlled and/or on the Ingredient Disclosure List (HPA sections 13 and 14).

Country

Regulation

All Components Listed

SECTION 16. ADDITIONAL INFORMATION

Hazardous Material Information System (HMIS)

HEALTH	3
FLAMMABILITY	1
PHYSICAL HAZARD	0
PERSONAL PROTECTION	H

HMIS & NFPA Hazard Rating Legend

* = Chronic Health Hazard
0 = INSIGNIFICANT
1 = SLIGHT
2 = MODERATE
3 = HIGH

National Fire Protection Association (NFPA)

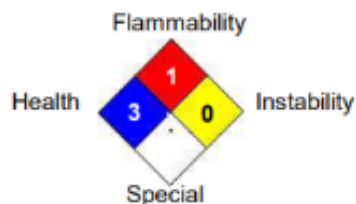

Date revised: 2023-08-08

Date Prepared: 8/8/2023

Reviewer Revision

SDS SHEETS - DC1000E CATALYST BLUE (US)



SAFETY DATA SHEET

PICOTE BRUSH COATING™ EPOXY RESIN
DUAL COAT CATALYST (COLOR:BLUE)

Revision date: 08-29-2023

SAFETY DATA SHEET

SECTION 1 . IDENTIFICATION

Product Name: DUAL COAT CATALYST BLUE Product Code: Picote DC1000 E CAT BLUE

PICOTE SOLUTIONS
20810 SE 18TH PL
SAMMAMISH, WA 98075

EMERGENCY CONTACT: INFOTRAC
DOMESTIC & CANADA: 800-535-5053
INTERNATIONAL: 352-323-3500
MANUFACTURER CONTACT:
PICOTE SOLUTIONS
RYAN BOLDAN
777 WEST PINNACLE PEAK RD, STE. B108, PHOENIX, AZ 85027
TEL: 1.480.622.8314

SECTION 2. HAZARD(S) IDENTIFICATION

GHS Ratings:

Acute Toxicity - Oral	4	Oral>300+<=2000mg/kg
Skin corrosion/irritation	2	Reversible adverse effects in dermal tissue, Draize score: >= 2.3 < 4.0 or persistent inflammation
Serious eye damage/eye irritation	1	Serious eye damage: Irreversible damage 21 days after exposure, Draize score: Corneal opacity >= 3, Iritis > 1.5
Skin sensitization	1	Skin sensitizer
Reproductive toxicity	2	Human or animal evidence possibly with other information

GHS Hazards

H302	Harmful if swallowed
H315	Causes skin irritation
H317	May cause an allergic skin reaction
H318	Causes serious eye damage
H361	Suspected of damaging fertility or the unborn children

GHS Precautions

P201	Obtain special instructions before use
P202	Do not handle until all safety precautions have been read and understood Avoid
P261	breathing dust/fume/gas/mist/vapours/spray
P264	Wash ... thoroughly after handling
P270	Do not eat, drink or smoke when using this product
P272	Contaminated work clothing should not be allowed out of the workplace
P280	Wear protective gloves/protective clothing/eye protection/face protection
P281	Use personal protective equipment as required
P310	Immediately call a POISON CENTER or doctor/physician
P321	Specific treatment (see ... on this label)
P330	Rinse mouth
P362	Take off contaminated clothing and wash before reuse
P363	Wash contaminated clothing before reuse
P301+P312	IF SWALLOWED: Call a POISON CENTER or doctor/physician if you feel unwell
P302+P352	IF ON SKIN: Wash with soap and water
P305+P351+P338	IF IN EYES: Rinse continuously with water for several minutes. Remove contact lenses if present and easy to do – continue rinsing
P308+P313	IF exposed or concerned: Get medical advice/attention
P332+P313	If skin irritation occurs: Get medical advice/attention
P333+P313	If skin irritation or a rash occurs: Get medical advice/attention
P405	Store locked up
P501	Dispose of contents/container to ...

SDS SHEETS - DC1000E CATALYST BLUE (US)

Signal Word: Danger



SECTION 3. COMPOSITION/INFORMATION ON INGREDIENTS

Chemical Name	CAS number	Weight Concentration %
Paratertiarybutylphenol	98-54-4	30.00% - 40.00%
Amine	1477-55-0	20.00% - 30.00%
1,5-Pentanediamine, 2 methyl	15520-10-2	20.00% - 30.00%
Silica	67762-90-7	5.00% - 10.00%
nonyl phenol	84852-15-3	1.00% - 5.00%
Copper Phthalocyanine	147-14-8	1.00% - 5.00%

SECTION 4. FIRST AID MEASURES

If inhaled remove to fresh air. If breathing is difficult, give oxygen. Obtain medical advice if there are persistent symptoms

Rinse immediately with plenty of water for at least 15 minutes. Ensure adequate flushing of the eyes by separating the eyelids with fingers. Remove contacts if present and easy to do. Continue Rinsing. Get medical attention, if irritation or symptoms of overexposure persists.

Immediately wash skin with soap and plenty of water.

If swallowed, call a physician immediately. Only induce vomiting at the instruction of a physician. Never give anything by mouth to an unconscious person

SECTION 5. FIRE FIGHTING MEASURES

Flash Point: 134 C (273 F)

LEL: N/A

UEL: N/A

Not applicable

Foam, Carbon dioxide (CO₂) or dry chemical or water spray (water stream may be ineffective).

No information available

Not available

Firefighters, and others exposed, wear self-contained breathing apparatus.

SECTION 6. ACCIDENTAL RELEASE MEASURES

Stop leak. Dike or contain spill. Pump into slavage tanks and/or absorb with suitable material. Use sparkless shovel to remove material. Evacuate area and keep unnecessary and unprotected personnel from entering the spill area. Use appropriate containment and clean up immediately.

Corrosive. Avoid personal contact and breathing vapor or mist. Stop leak, Dike and contain spill. Prevent spilled material from entering the ground, water and/or air by using appropriate containment methods.

SECTION 7. HANDLING and STORAGE

Avoid breathing vapor. Avoid contact with eyes, skin and clothing. Keep away from heat and flame. Keep container closed. Use with adequate ventilation. Wash thoroughly after handling.

Avoid exposure to heat, light, and air for prolonged periods of time. Store in a cool, dry well ventilated area away from sources of heat and incompatible materials. Eliminate all ignition materials and incompatible materials. Collect spill with non spark tools.

No information available.

SDS SHEETS - DC1000E CATALYST BLUE (US)

SECTION 8. EXPOSURE CONTROLS, PERSONAL PROTECTION			
Chemical Name / CAS No.	OSHA Exposure Limits	ACGIH Exposure Limits	Other Exposure Limits
Paratertiarybutylphenol 98-54-4	Not Established	Not Established	Not Established
Amine 1477-55-0	Not Established	0.1 mg/m3 Ceiling	NIOSH: 0.1 mg/m3 Ceiling
1,5-Pentanediamine, 2 methyl 15520-10-2	Not Established	Not Established	Not Established
Silica 67762-90-7	Not Established	Not Established	Not Established
nonyl phenol 84852-15-3	Not Established	Not Established	Not Established
Copper Phthalocyanine 147-14-8	Not Established	Not Established	Not Established

Use appropriate engineering control such as process enclosures, local exhaust ventilation, or other engineering controls to control airborne levels below recommended exposure limits. Good general ventilation should be sufficient to control airborne levels. Where such systems are not effective wear suitable personal protective equipment, which performs satisfactory and meets OSHA or other recognized standards. Consult with local procedures for selection, training, and maintenance of the personal protective equipment. Always use adequate ventilation that comply with local regulations.

Eye/Face Protection: Wear appropriate protective glasses or splash goggles as described by 29 CFR 1910.133, OSHA eye and face protection regulation, or the European standard EN 166

Skin Protection: Chemical-resistant gloves and chemical goggles, face-shield and synthetic apron or coveralls should be used to prevent contact with eyes, skin or clothing.

Respiratory Protection: A NIOSH air purifying respirator with an organic vapor cartridge or canister may be permissible under certain circumstances where airborne concentrations are expected to exceed exposure limits. Protection provided by air purifying respirators is limited. Use a positive pressure air supplied respirator if there is any potential for an uncontrolled release, exposure levels are not known or any other circumstance where air purifying respirator may not provide adequate protection.

SECTION 9. PHYSICAL and CHEMICAL PROPERTIES

Boiling Point 247 °C Lbs VOC/Gallon Less Water 0.00 % VOL by Volume 0.00	Specific Gravity (SG) 0.990 Lbs VOC/Gallon Less 0.00 Exempt
---	--

SECTION 10. STABILITY and REACTIVITY

Stable, Hazardous polymerization will not occur. Will react with Epoxy Resins especially at elevated temperatures

STABLE

Epoxy Resins under uncontrolled conditions. Mineral acids. Organic acid, oxidizers, Reacts with metals until reacted with epoxy. Nitrogen oxides and other toxic and acidic gasses when burned.

None known

Hazardous polymerization will not occur.

SECTION 11. TOXICOLOGICAL INFORMATION

Mixture Toxicity

Oral Toxicity LD50: 1,894mg/kg

SDS SHEETS - DC1000E CATALYST BLUE (US)

Dermal Toxicity LD50: 3,184mg/kg
Inhalation Toxicity LC50: 2,872mg/L

Component Toxicity

98-54-4	Paratertiarybutylphenol Oral LD50: 3,250 µL/kg (Rat) Dermal LD50: 2,318 mg/kg (Rabbit)
1477-55-0	Amine Oral LD50: 660 mg/kg (Rat) Dermal LD50: 2 g/kg (Rabbit) Inhalation LC50: 700 ppm (Rat)
84852-15-3	nonyl phenol Oral LD50: 1,300 mg/kg (Rat) Dermal LD50: 2,031 mg/kg (Rabbit)

Eyes: Irritant to the eyes. Corrosive to Eyes

Skin: Irritant to the skin. Corrosive to Skin

Inhalation: Irritant to respiratory tract. Prolonged or excessive inhalation may cause respiratory tract irritation.

Sensitization: Skin sensitization in humans.

Eyes Kidneys Liver Skin Respiratory System

Effects of Overexposure

<u>CAS Number</u>	<u>Description</u>	<u>% Weight</u>	<u>Carcinogen Rating</u>
-------------------	--------------------	-----------------	--------------------------

Avoid breathing vapors

Oral: N.D.A.

Dermal: N.D.A.

Inhalation: N.D.A.

SECTION 12. ECOLOGICAL INFORMATION

No ecotoxicity data was found for the product

Component Ecotoxicity

Paratertiarybutylphenol	96 Hr LC50 Pimephales promelas: 4.71 - 5.62 mg/L [flow-through]; 96 Hr LC50 Cyprinus carpio: 6.9 mg/L [static] 48 Hr EC50 Daphnia magna: 3.9 mg/L; 48 Hr EC50 Daphnia magna: 3.4 - 4.5 mg/L [Static] 72 Hr EC50 Desmodesmus subspicatus: 11.2 mg/L
nonyl phenol	96 Hr LC50 Pimephales promelas: 0.135 mg/L [flow-through]; 96 Hr LC50 Lepomis macrochirus: 0.1351 mg/L [flow-through] 48 Hr EC50 Daphnia magna: 0.14 mg/L 96 Hr EC50 Pseudokirchneriella subcapitata: 0.36 - 0.48 mg/L [static]; 72 Hr EC50 Pseudokirchneriella subcapitata: 0.16 - 0.72 mg/L [static]; 72 Hr EC50 Desmodesmus subspicatus: 1.3 mg/L

SECTION 13. DISPOSAL INFORMATION

Dispose of in accordance with applicable local/municipal, state/provincial and federal regulations.

SECTION 14. TRANSPORT INFORMATION

UN Number: UN2735

Proper Shipping Name: Amines, liquid, corrosive, n.o.s.

Technical Name: Benzene-1,3-Dimethanamine,1,5-Pentanediamine, 2-Mthyl.

Transportation Hazardous Shipping Class: 8

Packing Group: II

Hazardous Label: 8 Corrosive Substance

Environmental Hazards-Marine Pollutant: Yes

SDS SHEETS - DC1000E BASE WHITE (US)



SAFETY DATA SHEET

PICOTE BRUSH COATING™ EPOXY RESIN
DUAL COAT BASE (COLOR:WHITE)

Revision date: 08-9-2023

SAFETY DATA SHEET

SECTION 1 . IDENTIFICATION

Product Name: DUAL COAT BASE WHITE Product Code: PICOTE DC1000E BASE WHITE

Trade Name: DUAL COAT BASE

PICOTE SOLUTIONS
20810 SE 18TH PL
SAMMAMISH, WA 98075

EMERGENCY CONTACT: INFOTRAC
DOMESTIC & CANADA: 800-535-5053
INTERNATIONAL: 352-323-3500

MANUFACTURER CONTACT:
PICOTE SOLUTIONS
RYAN BOLDAN
777 WEST PINNACLE PEAK RD, STE. B108
PHOENIX, AZ 85027
TEL: 1.480.622.8314

SECTION 2. HAZARD(S) IDENTIFICATION

GHS Ratings:

Skin corrosion/irritation	3	Reversible adverse effects in dermal tissue, Draize score: >= 1.5 < 2.3
Skin sensitization	1	Skin sensitizer
Carcinogenicity	2	Limited evidence of human or animal carcinogenicity

GHS Hazards

H316	Causes mild skin irritation
H317	May cause an allergic skin reaction
H351	Suspected of causing cancer

GHS Precautions

P201	Obtain special instructions before use
P202	Do not handle until all safety precautions have been read and understood
P261	Avoid breathing dust/fume/gas/mist/vapours/spray
P272	Contaminated work clothing should not be allowed out of the workplace
P280	Wear protective gloves/protective clothing/eye protection/face protection
P281	Use personal protective equipment as required
P321	Specific treatment (see ... on this label)
P363	Wash contaminated clothing before reuse
P302+P352	IF ON SKIN: Wash with soap and water
P308+P313	IF exposed or concerned: Get medical advice/attention
P332+P313	If skin irritation occurs: Get medical advice/attention
P333+P313	If skin irritation or a rash occurs: Get medical advice/attention
P405	Store locked up
P501	Dispose of contents/container to ...

Signal Word: Warning



SDS SHEETS - DC1000E BASE WHITE (US)

SECTION 3. COMPOSITION/INFORMATION ON INGREDIENTS

Chemical Name	CAS number	Weight Concentration %
Epoxy Resin	25085-99-8	40.00% - 50.00%
Barium Sulfate	7727-43-7	20.00% - 30.00%
Titanium Dioxide	13463-67-7	10.00% - 20.00%
Proprietary	68609-97-2	5.00% - 10.00%

SECTION 4. FIRST AID MEASURES

If inhaled remove to fresh air. If breathing is difficult, give oxygen. Obtain medical advice if there are persistent symptoms

Rinse immediately with plenty of water for at least 15 minutes.

Immediately wash skin with soap and plenty of water.

If swallowed, call a physician immediately. Only induce vomiting at the instruction of a physician. Never give anything by mouth to an unconscious person

SECTION 5. FIRE FIGHTING MEASURES

Flash Point: 252 C (486 F)

LEL: N/A

UEL: N/A

Not applicable

Foam, Carbon dioxide (CO₂) or dry chemical or water spray (water stream may be ineffective).

No information available

Not available

Keep people away. Isolate fire area and deny unnecessary entry. Do not use direct water stream. May spread fire. Use water spray to cool fire exposed containers and fire affected zone until fire is out and danger of re-ignition has passed. Fight Fire from protected location or safe distance.

Firefighters, and others exposed, wear self-contained breathing apparatus.

SECTION 6. ACCIDENTAL RELEASE MEASURES

Stop leak. Dike or contain spill. Pump into slavage tanks and/or absorb with suitable material. Use sparkless shovel to remove material

Use appropriate containment and clean up immediately.

Stop leak, Dike and contain spill. Prevent spilled material from entering the ground, water and/or air by using appropriate containment methods

SECTION 7. HANDLING and STORAGE

Avoid breathing vapor. Avoid contact with eyes, skin and clothing. Keep away from heat and flame. Keep container closed. Use with adequate ventilation. Wash thoroughly after handling.

Avoid exposure to heat, light, and air for prolonged periods of time.

No information available.

SECTION 8. EXPOSURE CONTROLS, PERSONAL PROTECTION

Chemical Name / CAS No.	OSHA Exposure Limits	ACGIH Exposure Limits	Other Exposure Limits
Epoxy Resin 25085-99-8	Not Established	Not Established	Not Established
Barium Sulfate 7727-43-7	15 mg/m ³ TWA (total dust); 5 mg/m ³ TWA (respirable fraction)	5 mg/m ³ TWA (inhalable fraction, particulate matter containing no asbestos and <1% crystalline silica)	NIOSH: 10 mg/m ³ TWA (total dust); 5 mg/m ³ TWA (respirable dust)
Titanium Dioxide 13463-67-7	15 mg/m ³ TWA (total dust)	10 mg/m ³ TWA	Not Established

PICOTE DC1000E RESIN SYSTEM

Version:
August 16, 2024

SDS SHEETS - DC1000E BASE WHITE (US)

Proprietary 68609-97-2	Not Established	Not Established	Not Established
---------------------------	-----------------	-----------------	-----------------

Eye Protection

Protective eye wear is required when handling to prevent exposure to eyes.

Skin Protection

Use chemical resistant gloves when handling

Dispose of contaminated gear

SECTION 9. PHYSICAL and CHEMICAL PROPERTIES

Appearance: Not Applicable Vapor Pressure: 10.0 mmHg Vapor Density: N/A Specific Gravity: 1.70 Freezing point: Not Applicable Boiling range: 2500 - 3000°C Evaporation rate: Not Applicable Explosive Limits: N/A Autoignition temperature: N/A Viscosity: Not Applicable % Solids by Volume 0.36 Lbs / Gal 14.19	Odor: Not Applicable Odor threshold: Not Applicable pH: Not Applicable Melting point: Not Applicable Solubility: Not Applicable Flash point: 486°F, 252°C Flammability: 486°F, 252°C Partition coefficient (n- octanol/water): Not Applicable Decomposition temperature: Not Applicable % VOL by Volume 0.00 % Solids by Weight 0.03
--	---

SECTION 10. STABILITY and REACTIVITY

STABLE

Hazardous polymerization will not occur.

SECTION 11. TOXICOLOGICAL INFORMATION

Mixture Toxicity

Component Toxicity

Eyes Respiratory System

Effects of Overexposure

PICOTE DC1000E RESIN SYSTEM

Version:
August 16, 2024

SDS SHEETS - DC100E BASE WHITE (US)

CAS Number
13463-67-7

Description
Titanium Dioxide

% Weight
10% - 20%

Carcinogen Rating
Titanium Dioxide: NIOSH:
potential occupational carcinogen
IARC: Possible human carcinogen
OSHA: listed

SECTION 12. ECOLOGICAL INFORMATION

Component Ecotoxicity

SECTION 13. DISPOSAL INFORMATION

Dispose of in accordance with applicable local/municipal, state/provincial and federal regulations.

SECTION 14. TRANSPORT INFORMATION

UN3082 Environmentally Hazardous Substance, Liquid N.O.S. (Epoxy Resin)
Packaging Group III:
Hazardous Class 9

<u>Agency</u>	<u>Proper Shipping Name</u>	<u>UN Number</u>	<u>Packing Group</u>	<u>Hazard Class</u>
---------------	-----------------------------	------------------	----------------------	---------------------

SECTION 15. REGULATORY INFORMATION

<u>Country</u>	<u>Regulation</u>	<u>All Components Listed</u>
----------------	-------------------	------------------------------

SECTION 16. ADDITIONAL INFORMATION

Hazardous Material Information System (HMIS)

HEALTH	2
FLAMMABILITY	1
PHYSICAL HAZARD	0
PERSONAL PROTECTION	C

HMIS & NFPA Hazard Rating
Legend
* = Chronic Health Hazard
0 = INSIGNIFICANT
1 = SLIGHT
2 = MODERATE
3 = HIGH

National Fire Protection Association (NFPA)

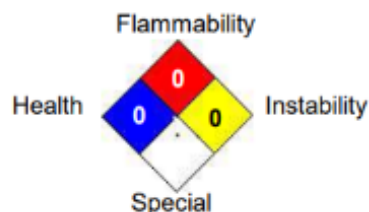

Date revised: 2023-08-08

Date Prepared: 8/8/2023

Reviewer Revision

SDS SHEETS - DC1000E BASE GREY (US)



SAFETY DATA SHEET

PICOTE BRUSH COATING™ EPOXY RESIN
DUAL COAT BASE (COLOR:GRAY)

Revision date: 8-9-2023

SAFETY DATA SHEET

SECTION 1 . IDENTIFICATION

Product Name: DUAL COAT BASE GRAY Product Code: PICOTE DC1000E BASE GRAY

PICOTE SOLUTIONS
20810 SE 18TH PL
SAMMAMISH, WA 98075

EMERGENCY CONTACT: INFOTRAC
DOMESTIC & CANADA: 800-535-5053
INTERNATIONAL: 352-323-3500

MANUFACTURER CONTACT:
PICOTE SOLUTIONS
RYAN BOLDAN
777 WEST PINNACLE PEAK RD, STE. B108
PHOENIX, AZ 85027
TEL: 1.480.622.8314

SECTION 2. HAZARD(S) IDENTIFICATION

GHS Ratings:

Skin corrosion/irritation	3	Reversible adverse effects in dermal tissue, Draize score: >= 1.5 < 2.3
Skin sensitization	1	Skin sensitizer
Carcinogenicity	2	Limited evidence of human or animal carcinogenicity

GHS Hazards

H316	Causes mild skin irritation
H317	May cause an allergic skin reaction
H351	Suspected of causing cancer

GHS Precautions

P201	Obtain special instructions before use
P202	Do not handle until all safety precautions have been read and understood
P261	Avoid breathing dust/fume/gas/mist/vapours/spray
P272	Contaminated work clothing should not be allowed out of the workplace
P280	Wear protective gloves/protective clothing/eye protection/face protection
P281	Use personal protective equipment as required
P321	Specific treatment (see ... on this label)
P363	Wash contaminated clothing before reuse
P302+P352	IF ON SKIN: Wash with soap and water
P308+P313	IF exposed or concerned: Get medical advice/attention
P332+P313	If skin irritation occurs: Get medical advice/attention
P333+P313	If skin irritation or a rash occurs: Get medical advice/attention
P405	Store locked up
P501	Dispose of contents/container to ...

Signal Word: Warning



SECTION 3. COMPOSITION/INFORMATION ON INGREDIENTS

PICOTE DC1000E RESIN SYSTEM

Version:
August 16, 2024

SDS SHEETS - DC1000E BASE GREY (US)

Chemical Name	CAS number	Weight Concentration %
Epoxy Resin	25085-99-8	50.00% - 60.00%
Barium Sulfate	7727-43-7	20.00% - 30.00%
Titanium Dioxide	13463-67-7	10.00% - 20.00%
Proprietary	68609-97-2	5.00% - 10.00%
Inert	INERT	1.00% - 5.00%
Black Pigment	1333-86-4	0.10% - 1.00%

SECTION 4. FIRST AID MEASURES

If inhaled remove to fresh air. If breathing is difficult, give oxygen. Obtain medical advice if there are persistent symptoms

Rinse immediately with plenty of water for at least 15 minutes.

Immediately wash skin with soap and plenty of water.

If swallowed, call a physician immediately. Only induce vomiting at the instruction of a physician. Never give anything by mouth to an unconscious person

SECTION 5. FIRE FIGHTING MEASURES

Flash Point: 252 C (486 F)

LEL: N/A

UEL: N/A

Not applicable

Foam, Carbon dioxide (CO₂) or dry chemical or water spray (water stream may be ineffective).

No information available

Not available

Keep people away. Isolate fire area and deny unnecessary entry. Do not use direct water stream. May spread fire. Use water spray to cool fire exposed containers and fire affected zone until fire is out and danger of re-ignition has passed. Fight Fire from protected location or safe distance.

Firefighters, and others exposed, wear self-contained breathing apparatus.

SECTION 6. ACCIDENTAL RELEASE MEASURES

Stop leak. Dike or contain spill. Pump into slavage tanks and/or absorb with suitable material. Use sparkless shovel to remove material

Use appropriate containment and clean up immediately.

Stop leak, Dike and contain spill. Prevent spilled material from entering the ground, water and/or air by using appropriate containment methods

SECTION 7. HANDLING and STORAGE

Avoid breathing vapor. Avoid contact with eyes, skin and clothing. Keep away from heat and flame. Keep container closed. Use with adequate ventilation. Wash thoroughly after handling.

Avoid exposure to heat, light, and air for prolonged periods of time.

No information available.

SECTION 8. EXPOSURE CONTROLS, PERSONAL PROTECTION

Chemical Name / CAS No.	OSHA Exposure Limits	ACGIH Exposure Limits	Other Exposure Limits
Epoxy Resin 25085-99-8	Not Established	Not Established	Not Established
Barium Sulfate 7727-43-7	15 mg/m ³ TWA (total dust); 5 mg/m ³ TWA (respirable fraction)	5 mg/m ³ TWA (inhalable fraction, particulate matter containing no asbestos and <1% crystalline silica)	NIOSH: 10 mg/m ³ TWA (total dust); 5 mg/m ³ TWA (respirable dust)

PICOTE DC1000E RESIN SYSTEM

Version:
August 16, 2024

SDS SHEETS - DC1000E BASE GREY (US)

Titanium Dioxide 13463-67-7	15 mg/m3 TWA (total dust)	10 mg/m3 TWA	Not Established
Proprietary 68609-97-2	Not Established	Not Established	Not Established
Inert INERT	Not Established	Not Established	Not Established
Black Pigment 1333-86-4	3.5 mg/m3 TWA	3 mg/m3 TWA (inhalable fraction)	NIOSH: 3.5 mg/m3 TWA; 0.1 mg/m3 TWA (Carbon black in presence of Polycyclic aromatic hydrocarbons, as PAH)

Eye Protection

Protective eye wear is required when handling to prevent exposure to eyes.

Skin Protection

Use chemical resistant gloves when handling

Dispose of contaminated gear

SECTION 9. PHYSICAL and CHEMICAL PROPERTIES

Boiling Range 2500 to 3000 °C Lbs VOC/Gallon Less Water 0.00 % VOL by Volume 0.00	Specific Gravity (SG) 1.624 Lbs VOC/Gallon Less 0.00 Exempt
--	--

SECTION 10. STABILITY and REACTIVITY

STABLE

Hazardous polymerization will not occur.

SECTION 11. TOXICOLOGICAL INFORMATION

Mixture Toxicity

Component Toxicity

Eyes Respiratory System

Effects of Overexposure

PICOTE DC1000E RESIN SYSTEM

Version:
August 16, 2024

SDS SHEETS - DC1000E BASE GREY (US)

<u>CAS Number</u>	<u>Description</u>	<u>% Weight</u>	<u>Carcinogen Rating</u>
13463-67-7	Titanium Dioxide	10% - 20%	Titanium Dioxide: NIOSH: potential occupational carcinogen IARC: Possible human carcinogen OSHA: listed
1333-86-4	Black Pigment	0.1% - 1.0%	Black Pigment: NIOSH: potential occupational carcinogen IARC: Possible human carcinogen OSHA: listed

SECTION 12. ECOLOGICAL INFORMATION

Component Ecotoxicity

SECTION 13. DISPOSAL INFORMATION

Dispose of in accordance with applicable local/municipal, state/provincial and federal regulations.

SECTION 14. TRANSPORT INFORMATION

UN3082 Environmentally Hazardous Substance, Liquid N.O.S. (Epoxy Resin)

Packaging Group III:

Hazardous Class 9

<u>Agency</u>	<u>Proper Shipping Name</u>	<u>UN Number</u>	<u>Packing Group</u>	<u>Hazard Class</u>
---------------	-----------------------------	------------------	----------------------	---------------------

SECTION 15. REGULATORY INFORMATION

<u>Country</u>	<u>Regulation</u>	<u>All Components Listed</u>
----------------	-------------------	------------------------------

SECTION 16. ADDITIONAL INFORMATION

Hazardous Material Information System (HMIS)

HEALTH	2
FLAMMABILITY	1
PHYSICAL HAZARD	0
PERSONAL PROTECTION	C

HMIS & NFPA Hazard Rating

Legend

* = Chronic Health Hazard

0 = INSIGNIFICANT

1 = SLIGHT

2 = MODERATE

3 = HIGH

National Fire Protection Association (NFPA)

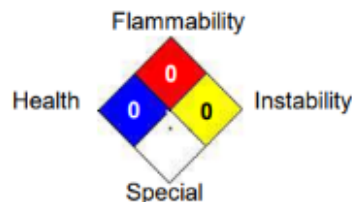

Date revised: 2023-08-08

Date Prepared: 8/8/2023

Reviewer Revision

SDS SHEETS - DC1000E FAST CURE CATALYST CLEAR (US)



SAFETY DATA SHEET

PICOTE BRUSH COATING™ EPOXY RESIN
FAST CURE CATALYST (COLOR: CLEAR)

Revision date: 08-29-2023

SAFETY DATA SHEET

SECTION 1 . IDENTIFICATION

Product Name: DUAL COAT RAPID SET CATALYST (10MIN) Product Code: Picote DC1000E RS CAT

PICOTE SOLUTIONS
20810 SE 18TH PL
SAMMAMISH, WA 98075

EMERGENCY CONTACT: INFOTRAC
DOMESTIC & CANADA: 800-535-5053
INTERNATIONAL: 352-323-3500
MANUFACTURER CONTACT:
PICOTE SOLUTIONS
RYAN BOLDAN
777 WEST PINNACLE PEAK RD, STE. B108, PHOENIX, AZ 85027
TEL: 1.480.622.8314

SECTION 2. HAZARD(S) IDENTIFICATION

GHS Ratings:

Flammable liquid	4	Flash point $\geq 60^{\circ}\text{C}$ (140°F) and $\leq 93^{\circ}\text{C}$ (200°F)
Skin corrosive	2	Reversible adverse effects in dermal tissue, Draize score: $\geq 2.3 < 4.0$ or persistent inflammation
Eye corrosive	1	Serious eye damage: Irreversible damage 21 days after exposure, Draize score: Corneal opacity ≥ 3 , Iritis > 1.5
Skin sensitizer	1	Skin sensitizer
Reproductive toxin	2	Human or animal evidence possibly with other information

GHS Hazards

H227	Combustible liquid
H315	Causes skin irritation
H317	May cause an allergic skin reaction
H318	Causes serious eye damage
H361	Suspected of damaging fertility or the unborn child

GHS Precautions

P201	Obtain special instructions before use
P202	Do not handle until all safety precautions have been read and understood
P210	Keep away from heat/sparks/open flames/hot surfaces – No smoking
P235	Keep cool
P261	Avoid breathing dust/fume/gas/mist/vapours/spray
P264	Wash ... thoroughly after handling
P272	Contaminated work clothing should not be allowed out of the workplace
P280	Wear protective gloves/protective clothing/eye protection/face protection
P281	Use personal protective equipment as required
P310	Immediately call a POISON CENTER or doctor/physician
P321	Specific treatment (see ... on this label)
P362	Take off contaminated clothing and wash before reuse
P363	Wash contaminated clothing before reuse
P302+P352	IF ON SKIN: Wash with soap and water
P305+P351+P338	IF IN EYES: Rinse continuously with water for several minutes. Remove contact lenses if present and easy to do – continue rinsing
P308+P313	IF exposed or concerned: Get medical advice/attention
P332+P313	IF skin irritation occurs: Get medical advice/attention
P333+P313	IF skin irritation or a rash occurs: Get medical advice/attention
P370+P378	In case of fire: Use ... for extinction
P405	Store locked up
P403+P235	Store in a well ventilated place. Keep cool
P501	Dispose of contents/container to ...

SDS SHEETS - DC1000E FAST CURE CATALYST CLEAR (US)

Signal Word: **Danger**



SECTION 3. COMPOSITION/INFORMATION ON INGREDIENTS

Chemical Name	CAS number	Weight Concentration %
Amine	217-168-8	60.00% - 70.00%
Amine	1477-55-0	10.00% - 20.00%
Benzyl Alcohol	100-51-6	5.00% - 10.00%
Proprietary	Proprietary	7.60%
Silica	67762-90-7	1.00% - 5.00%

SECTION 4. FIRST AID MEASURES

If inhaled remove to fresh air. If breathing is difficult, give oxygen. Obtain medical advice if there are persistent symptoms

Rinse immediately with plenty of water for at least 15 minutes. Ensure adequate flushing of the eyes by separating the eyelids with fingers. Remove contacts if present and easy to do. Continue Rinsing. Get medical attention, if irritation or symptoms of overexposure persists.

Immediately wash skin with soap and plenty of water.

If swallowed, call a physician immediately. Only induce vomiting at the instruction of a physician. Never give anything by mouth to an unconscious person

SECTION 5. FIRE FIGHTING MEASURES

Flash Point: 93 C (199 F)

LEL: N/A

UEL: N/A

Not applicable

Foam, Carbon dioxide (CO₂) or dry chemical or water spray (water stream may be ineffective).

No information available

Not available

Firefighters, and others exposed, wear self-contained breathing apparatus.

SECTION 6. ACCIDENTAL RELEASE MEASURES

Stop leak. Dike or contain spill. Pump into slavage tanks and/or absorb with suitable material. Use sparkless shovel to remove material. Evacuate area and keep unnecessary and unprotected personnel from entering the spill area.

Use appropriate containment and clean up immediately.

Corrosive. Avoid personal contact and breathing vapor or mist. Stop leak, Dike and contain spill. Prevent spilled material from entering the ground, water and/or air by using appropriate containment methods.

SECTION 7. HANDLING and STORAGE

Avoid breathing vapor. Avoid contact with eyes, skin and clothing. Keep away from heat and flame. Keep container closed. Use with adequate ventilation. Wash thoroughly after handling.

Avoid exposure to heat, light, and air for prolonged periods of time. Store in a cool, dry well ventilated area away from

SDS SHEETS - DC1000E FAST CURE CATALYST CLEAR (US)

sources of heat and incompatible materials. Eliminate all ignition materials and incompatible materials. Collect spill with non spark tools.

No information available.

SECTION 8. EXPOSURE CONTROLS, PERSONAL PROTECTION

Chemical Name / CAS No.	OSHA Exposure Limits	ACGIH Exposure Limits	Other Exposure Limits
Amine 217-168-8	Not Established	Not Established	Not Established
Amine 1477-55-0	Not Established	0.1 mg/m ³ Ceiling	NIOSH: 0.1 mg/m ³ Ceiling
Benzyl Alcohol 100-51-6	Not Established	Not Established	Not Established
Proprietary Proprietary	Not Established	Not Established	Not Established
Silica 67762-90-7	Not Established	Not Established	Not Established

Use appropriate engineering control such as process enclosures, local exhaust ventilation, or other engineering controls to control airborne levels below recommended exposure limits. Always use adequate ventilation that comply with local regulations. Eye/face Protection: Wear appropriate protective glasses or splash goggles as described by 29 CFR 1910.133, OSHA eye and face Protection regulation, or the European standard EN 166
Skin Protection: Chemical-resistant gloves and chemical goggles, face-shield and synthetic apron or coveralls should be used to prevent contact with eyes, skin or clothing. Respiratory Protection: A NIOSH air purifying respirator with an organic vapor cartridge or canister may be permissible under certain circumstances where airborne concentrations are expected to exceed exposure limits

SECTION 9. PHYSICAL and CHEMICAL PROPERTIES

Boiling Range 205 to 247 °C Lbs VOC/Gallon Less Water 0.00 % VOL by Volume 0.00	Specific Gravity (SG) 1.092 Lbs VOC/Gallon Less Exempt 0.00
--	--

SECTION 10. STABILITY and REACTIVITY

Stable, Hazardous polymerization will not occur. Will react with Epoxy Resins especially at elevated temperatures

STABLE

Epoxy Resins under uncontrolled conditions. Mineral acids. Organic acid, oxidizers, Reacts with metals until reacted with epoxy.

None known

Hazardous polymerization will not occur.

SECTION 11. TOXICOLOGICAL INFORMATION

Mixture Toxicity

Oral Toxicity LD50: 3,907mg/kg

Inhalation Toxicity LC50: 92mg/L

Component Toxicity

1477-55-0

Amine

Oral LD50: 660 mg/kg (Rat) Dermal LD50: 2 g/kg (Rabbit) Inhalation LC50: 700 ppm (Rat)

100-51-6

Benzyl Alcohol

Oral LD50: 1,230 mg/kg (Rat) Dermal LD50: 2 g/kg (Rabbit) Inhalation LC50: 9 mg/L (Rat)

SDS SHEETS - DC1000E FAST CURE CATALYST CLEAR (US)

Eyes: Irritant to the eyes. Corrosive to Eyes
 Skin: Irritant to the skin. Corrosive to Skin
 Inhalation: Irritant to respiratory tract. Prolonged or excessive inhalation may cause respiratory tract irritation.
 Sensitization: Skin sensitization in humans.

Eyes Kidneys Liver Skin Respiratory System

Effects of Overexposure

CAS Number Description % Weight Carcinogen Rating

Avoid breathing vapors

Oral: N.D.A.
 Dermal: N.D.A.
 Inhalation: N.D.A.

SECTION 12. ECOLOGICAL INFORMATION

No ecotoxicity data was found for the product

Component Ecotoxicity

Benzyl Alcohol 96 Hr LC50 Pimephales promelas: 460 mg/L [static]; 96 Hr LC50 Lepomis macrochirus: 10 mg/L [static]
 48 Hr EC50 water flea: 23 mg/L

SECTION 13. DISPOSAL INFORMATION

Dispose of in accordance with applicable local/municipal, state/provincial and federal regulations.

SECTION 14. TRANSPORT INFORMATION

UN2735 Amines, Liquid, corrosive, n.o.s. (Benzene-1,3-Dimethanamine,1,5-Pentanediamine, 2-Mthyl).
 DOT Hazad Class 8
 DOT Packaging Class II

<u>Agency</u>	<u>Proper Shipping Name</u>	<u>UN Number</u>	<u>Packing Group</u>	<u>Hazard Class</u>
---------------	-----------------------------	------------------	----------------------	---------------------

SECTION 15. REGULATORY INFORMATION

OSHA:29 CFR 1910.1200 Haxardous Chemical "Irritant", Sensitizer
 (40 CFR 372.65) Supplier Notification Required

TSCA: Ingredients listed

SARA III: Sec311 & 312 Immediate Health Haxard; Sec313 Chemicals above de minimus level: None

CA PROP. 65 NOTICE WARNING:

CANADIAN REGULATORY INFORMATION

WHMIS: Hazard Classification: D2B Skin Sensitizer. Refer to SDS for specific warnings

WHMIS Symbols: Stylized T.

WHMIS Trade Secret Registry Numbers: None

Hazardous Products Act Infomrtion: This product SDS contains ingredients which are Controlled and/or on the Ingredient Disclosure List (HPA sections 13 and 14)

State of California Safe Drinking Water and Toxic Enforcement Act of 1986 (Proposition 65): WARNING! This product contains the following chemicals which are listed by the State of California as carcinogenic or a reproductive toxin:

217-168-8 Amine 60 - 70%
 100-51-6 Benzyl Alcohol 5 - 10%

The following chemicals are classified under SARA 313 Toxic Release Invetnory (TRI):

217-168-8 Amine 60 - 70%

PICOTE DC1000E RESIN SYSTEM

Version:
August 16, 2024

SDS SHEETS - DC1000E FAST CURE CATALYST CLEAR (US)

Country
EU

Regulation
REACH (EU) SUBSTANCES OF VERY HIGH CONCERN
Toxic Substance Control Act (TSCA)

All Components Listed
No
No

EU Risk Phrases

Safety Phrase

SECTION 16. ADDITIONAL INFORMATION

Hazardous Material Information System (HMIS)

HEALTH	3
FLAMMABILITY	1
PHYSICAL HAZARD	1
PERSONAL PROTECTION	H

HMIS & NFPA Hazard Rating
Legend
* = Chronic Health Hazard
0 = INSIGNIFICANT
1 = SLIGHT
2 = MODERATE
3 = HIGH

National Fire Protection Association (NFPA)

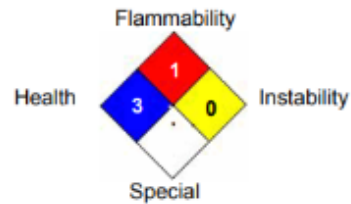

Date revised: 2019-08-08

Date Prepared: 8/8/2019

Reviewer Revision

SDS SHEETS - DC1000E FAST CURE BASE WHITE (US)



SAFETY DATA SHEET

PICOTE BRUSH COATING™ EPOXY RESIN
FAST CURE BASE (COLOR:WHITE)

Revision date: 08-29-2023

SAFETY DATA SHEET

SECTION 1 . INDENTIFICATION

Product Name: DUAL COAT BASE (White) Product Code: PICOTE DC1000E BASE WHITE

Trade Name: DUAL COAT BASE

PICOTE SOLUTIONS
20810 SE 18TH PL
SAMMAMISH, WA 98075

EMERGENCY CONTACT: INFOTRAC
DOMESTIC & CANADA: 800-535-5053
INTERNATIONAL: 352-323-3500
MANUFACTURER CONTACT:
PICOTE SOLUTIONS
RYAN BOLDAN
777 WEST PINNACLE PEAK RD, STE. B108
PHOENIX, AZ 85027
TEL: 1.480.622.8314

SECTION 2. HAZARD(S) IDENTIFICATION

GHS Ratings:

Skin corrosive	3	Reversible adverse effects in dermal tissue, Draize score: >= 1.5 < 2.3
Skin sensitizer	1	Skin sensitizer
Carcinogen	2	Limited evidence of human or animal carcinogenicity

GHS Hazards

H316	Causes mild skin irritation
H317	May cause an allergic skin reaction
H351	Suspected of causing cancer

GHS Precautions

P201	Obtain special instructions before use
P202	Do not handle until all safety precautions have been read and understood
P261	Avoid breathing dust/fume/gas/mist/vapours/spray
P272	Contaminated work clothing should not be allowed out of the workplace
P280	Wear protective gloves/protective clothing/eye protection/face protection
P281	Use personal protective equipment as required
P321	Specific treatment (see ... on this label)
P363	Wash contaminated clothing before reuse
P302+P352	IF ON SKIN: Wash with soap and water
P308+P313	IF exposed or concerned: Get medical advice/attention
P332+P313	If skin irritation occurs: Get medical advice/attention
P333+P313	If skin irritation or a rash occurs: Get medical advice/attention
P405	Store locked up
P501	Dispose of contents/container to ...

Signal Word: Warning



SDS for: PICOTE FAST CURE DC1000E BASE WHITE

Page 1 of 4

PICOTE DC1000E RESIN SYSTEM

Version:
August 16, 2024

SDS SHEETS - DC1000E FAST CURE BASE WHITE (US)

SECTION 3. COMPOSITION/INFORMATION ON INGREDIENTS

Chemical Name	CAS number	Weight Concentration %
Epoxy Resin	25085-99-8	49.00%
Barium Sulfate	7727-43-7	20.00% - 30.00%
Titanium Dioxide	13463-67-7	10.00% - 20.00%
Proprietary	68609-97-2	5.00% - 10.00%

SECTION 4. FIRST AID MEASURES

If inhaled remove to fresh air. If breathing is difficult, give oxygen. Obtain medical advice if there are persistent symptoms

Rinse immediately with plenty of water for at least 15 minutes.

Immediately wash skin with soap and plenty of water.

If swallowed, call a physician immediately. Only induce vomiting at the instruction of a physician. Never give anything by mouth to an unconscious person

SECTION 5. FIRE FIGHTING MEASURES

Flash Point: N/A

LEL: N/A

UEL: N/A

Not applicable

Foam, Carbon dioxide (CO₂) or dry chemical or water spray (water stream may be ineffective).

No information available

Not available

Firefighters, and others exposed, wear self-contained breathing apparatus.

SECTION 6. ACCIDENTAL RELEASE MEASURES

Stop leak. Dike or contain spill. Pump into slavage tanks and/or absorb with suitable material. Use sparkless shovel to remove material

Use appropriate containment and clean up immediately.

Stop leak, Dike and contain spill. Prevent spilled material from entering the ground, water and/or air by using appropriate containment methods

SECTION 7. HANDLING and STORAGE

Avoid breathing vapor. Avoid contact with eyes, skin and clothing. Keep away from heat and flame. Keep container closed. Use with adequate ventilation. Wash thoroughly after handling.

Avoid exposure to heat, light, and air for prolonged periods of time.

No information available.

SECTION 8. EXPOSURE CONTROLS, PERSONAL PROTECTION

Chemical Name / CAS No.	OSHA Exposure Limits	ACGIH Exposure Limits	Other Exposure Limits
Epoxy Resin 25085-99-8	Not Established	Not Established	Not Established
Barium Sulfate 7727-43-7	15 mg/m ³ TWA (total dust); 5 mg/m ³ TWA (respirable fraction)	5 mg/m ³ TWA (inhalable fraction, particulate matter containing no asbestos and <1% crystalline silica)	NIOSH: 10 mg/m ³ TWA (total dust); 5 mg/m ³ TWA (respirable dust)
Titanium Dioxide 13463-67-7	15 mg/m ³ TWA (total dust)	10 mg/m ³ TWA	Not Established
Proprietary 68609-97-2	Not Established	Not Established	Not Established

SDS SHEETS - DC1000E FAST CURE BASE WHITE (US)

SECTION 9. PHYSICAL and CHEMICAL PROPERTIES

<p>Appearance: Not Applicable</p> <p>Vapor Pressure: 10.0 mmHg</p> <p>Vapor Density: N/A</p> <p>Specific Gravity: 1.70</p> <p>Freezing point: Not Applicable</p> <p>Boiling range: 2500 - 3000°C</p> <p>Evaporation rate: Not Applicable</p> <p>Explosive Limits: N/A</p> <p>Autoignition temperature: N/A</p> <p>Viscosity: Not Applicable</p> <p>% Solids by Volume 1.08</p> <p>Lbs / Gal 14.19</p>	<p>Odor: Not Applicable</p> <p>Odor threshold: Not Applicable</p> <p>pH: Not Applicable</p> <p>Melting point: Not Applicable</p> <p>Solubility: Not Applicable</p> <p>Flash point: 999°F,999°C</p> <p>Flammability: 999°F,999°C</p> <p>Partition coefficient (n- Not Applicable octanol/water):</p> <p>Decomposition temperature: Not Applicable</p> <p>% VOL by Volume 0.00</p> <p>% Solids by Weight 0.08</p>
--	--

SECTION 10. STABILITY and REACTIVITY

STABLE
Hazardous polymerization will not occur.

SECTION 11. TOXICOLOGICAL INFORMATION

Mixture Toxicity
Component Toxicity

Eyes Respiratory System

Effects of Overexposure

CAS Number	Description	% Weight	Carcinogen Rating
13463-67-7	Titanium Dioxide	10 to 20%	Titanium Dioxide: NIOSH: potential occupational carcinogen IARC: Possible human carcinogen OSHA: listed

SDS SHEETS - DC1000E FAST CURE BASE WHITE (US)

SECTION 12. ECOLOGICAL INFORMATION

Component Ecotoxicity

SECTION 13. DISPOSAL INFORMATION

Dispose of in accordance with applicable local/municipal, state/provincial and federal regulations.

SECTION 14. TRANSPORT INFORMATION

UN3082 Environmentally Hazardous Substance, Liquid N.O.S. (Epoxy Resin)

Packaging Group III:

Hazardous Class 9

Agency	Proper Shipping Name	UN Number	Hazard Class
--------	----------------------	-----------	--------------

SECTION 15. REGULATORY INFORMATION

State of California Safe Drinking Water and Toxic Enforcement Act of 1986 (Proposition 65): WARNING!

This product contains the following chemicals which are listed by the State of California as carcinogenic or a reproductive toxin:

13463-67-7 Titanium Dioxide 10 to 20 % Carcinogen

Country	Regulation	All Components Listed
EU	REACH (EU) SUBSTANCES OF VERY HIGH CONCERN Toxic Substance Control Act (TSCA)	No Yes

EU Risk Phrases

Safety Phrase

- None

SECTION 16. ADDITIONAL INFORMATION

Hazardous Material Information System (HMIS)

HEALTH	1	HMIS & NFPA Hazard Rating Legend * = Chronic Health Hazard 0 = INSIGNIFICANT 1 = SLIGHT 2 = MODERATE 3 = HIGH
FLAMMABILITY	1	
PHYSICAL HAZARD	2	
PERSONAL PROTECTION	B	

National Fire Protection Association (NFPA)

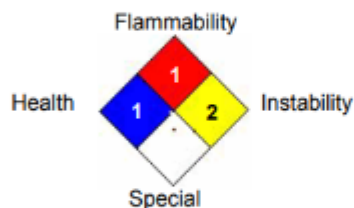

Date revised: 2017-02-02

Date Prepared: 4/18/2018

Reviewer Revision

SDS SHEETS - DC1000E FAST CURE BASE GREY (US)



SAFETY DATA SHEET

PICOTE BRUSH COATING™ EPOXY RESIN
FAST CURE BASE (COLOR:GRAY)

Revision date: 08-29-2023

SAFETY DATA SHEET

SECTION 1 . IDENTIFICATION

Product Name: DUAL COAT BASE (GRAY) Product Code: PICOTE FAST CURE DC1000E BASE GRAY

Trade Name: DUAL COAT BASE

PICOTE SOLUTIONS
20810 SE 18TH PL
SAMMAMISH, WA 98075

EMERGENCY CONTACT: INFOTRAC
DOMESTIC & CANADA: 800-535-5053
INTERNATIONAL: 352-323-3500
MANUFACTURER CONTACT:
PICOTE SOLUTIONS
RYAN BOLDAN
777 WEST PINNACLE PEAK RD, STE. B108
PHOENIX, AZ 85027
TEL: 1.480.622.8314

SECTION 2. HAZARD(S) IDENTIFICATION

GHS Ratings:

Skin corrosive	3	Reversible adverse effects in dermal tissue, Draize score: $\geq 1.5 < 2.3$
Skin sensitizer	1	Skin sensitizer
Carcinogen	2	Limited evidence of human or animal carcinogenicity

GHS Hazards

H316	Causes mild skin irritation
H317	May cause an allergic skin reaction
H351	Suspected of causing cancer

GHS Precautions

P201	Obtain special instructions before use
P202	Do not handle until all safety precautions have been read and understood
P261	Avoid breathing dust/fume/gas/mist/vapours/spray
P272	Contaminated work clothing should not be allowed out of the workplace
P280	Wear protective gloves/protective clothing/eye protection/face protection
P281	Use personal protective equipment as required
P321	Specific treatment (see ... on this label)
P363	Wash contaminated clothing before reuse
P302+P352	IF ON SKIN: Wash with soap and water
P308+P313	IF exposed or concerned: Get medical advice/attention
P332+P313	If skin irritation occurs: Get medical advice/attention
P333+P313	If skin irritation or a rash occurs: Get medical advice/attention
P405	Store locked up
P501	Dispose of contents/container to ...

Signal Word: Warning



SDS for: PICOTE FAST CURE DC1000E BASE GRAY

Page 1 of 4

PICOTE DC1000E RESIN SYSTEM

Version:
August 16, 2024

SDS SHEETS - DC1000E FAST CURE BASE GREY (US)

SECTION 3. COMPOSITION/INFORMATION ON INGREDIENTS

Chemical Name	CAS number	Weight Concentration %
Epoxy Resin	25085-99-8	49.00%
Barium Sulfate	7727-43-7	20.00% - 30.00%
Titanium Dioxide	13463-67-7	10.00% - 20.00%
Proprietary	68609-97-2	5.00% - 10.00%
Black Pigment	1333-86-4	0.10% - 1.00%

SECTION 4. FIRST AID MEASURES

If inhaled remove to fresh air. If breathing is difficult, give oxygen. Obtain medical advice if there are persistent symptoms

Rinse immediately with plenty of water for at least 15 minutes.

Immediately wash skin with soap and plenty of water.

If swallowed, call a physician immediately. Only induce vomiting at the instruction of a physician. Never give anything by mouth to an unconscious person

SECTION 5. FIRE FIGHTING MEASURES

Flash Point: N/A

LEL: N/A

UEL: N/A

Not applicable

Foam, Carbon dioxide (CO₂) or dry chemical or water spray (water stream may be ineffective).

No information available

Not available

Firefighters, and others exposed, wear self-contained breathing apparatus.

SECTION 6. ACCIDENTAL RELEASE MEASURES

Stop leak. Dike or contain spill. Pump into slavage tanks and/or absorb with suitable material. Use sparkless shovel to remove material

Use appropriate containment and clean up immediately.

Stop leak, Dike and contain spill. Prevent spilled material from entering the ground, water and/or air by using appropriate containment methods

SECTION 7. HANDLING and STORAGE

Avoid breathing vapor. Avoid contact with eyes, skin and clothing. Keep away from heat and flame. Keep container closed. Use with adequate ventilation. Wash thoroughly after handling.

Avoid exposure to heat, light, and air for prolonged periods of time.

No information available.

SECTION 8. EXPOSURE CONTROLS, PERSONAL PROTECTION

Chemical Name / CAS No.	OSHA Exposure Limits	ACGIH Exposure Limits	Other Exposure Limits
Epoxy Resin 25085-99-8	Not Established	Not Established	Not Established
Barium Sulfate 7727-43-7	15 mg/m ³ TWA (total dust); 5 mg/m ³ TWA (respirable fraction)	5 mg/m ³ TWA (inhalable fraction, particulate matter containing no asbestos and <1% crystalline silica)	NIOSH: 10 mg/m ³ TWA (total dust); 5 mg/m ³ TWA (respirable dust)
Titanium Dioxide 13463-67-7	15 mg/m ³ TWA (total dust)	10 mg/m ³ TWA	Not Established
Proprietary 68609-97-2	Not Established	Not Established	Not Established

PICOTE DC1000E RESIN SYSTEM

Version:
August 16, 2024

SDS SHEETS - DC1000E FAST CURE BASE GREY (US)

SECTION 9. PHYSICAL and CHEMICAL PROPERTIES

Appearance: Not Applicable Vapor Pressure: 10.0 mmHg Vapor Density: N/A Specific Gravity: 1.70 Freezing point: Not Applicable Boiling range: 2500 - 3000°C Evaporation rate: Not Applicable Explosive Limits: N/A Autoignition temperature: N/A Viscosity: Not Applicable % Solids by Volume: 1.08 Lbs / Gal: 14.19	Odor: Not Applicable Odor threshold: Not Applicable pH: Not Applicable Melting point: Not Applicable Solubility: Not Applicable Flash point: 999°F, 999°C Flammability: 999°F, 999°C Partition coefficient (n-octanol/water): Not Applicable Decomposition temperature: Not Applicable % VOL by Volume: 0.00 % Solids by Weight: 0.08
--	--

SECTION 10. STABILITY and REACTIVITY

STABLE

Hazardous polymerization will not occur.

SECTION 11. TOXICOLOGICAL INFORMATION

Mixture Toxicity

Component Toxicity

Eyes Respiratory System

Effects of Overexposure

CAS Number	Description	% Weight	Carcinogen Rating
13463-67-7	Titanium Dioxide	10 to 20%	Titanium Dioxide: NIOSH: potential occupational carcinogen IARC: Possible human carcinogen OSHA: listed

SDS SHEETS - DC1000E FAST CURE BASE GREY (US)

SECTION 12. ECOLOGICAL INFORMATION

Component Ecotoxicity

SECTION 13. DISPOSAL INFORMATION

Dispose of in accordance with applicable local/municipal, state/provincial and federal regulations.

SECTION 14. TRANSPORT INFORMATION

UN3082 Environmentally Hazardous Substance, Liquid N.O.S. (Epoxy Resin)
Packaging Group III:
Hazardous Class 9

Agency	Proper Shipping Name	UN Number	Hazard Class
--------	----------------------	-----------	--------------

SECTION 15. REGULATORY INFORMATION

State of California Safe Drinking Water and Toxic Enforcement Act of 1986 (Proposition 65): WARNING!
This product contains the following chemicals which are listed by the State of California as carcinogenic or a reproductive toxin:

13463-67-7 Titanium Dioxide 10 to 20 % Carcinogen

Country	Regulation	All Components Listed
EU	REACH (EU) SUBSTANCES OF VERY HIGH CONCERN	No
	Toxic Substance Control Act (TSCA)	Yes

EU Risk Phrases

Safety Phrase

- None

SECTION 16. ADDITIONAL INFORMATION

Hazardous Material Information System (HMIS)

HEALTH	1
FLAMMABILITY	1
PHYSICAL HAZARD	2
PERSONAL PROTECTION	B

HMIS & NFPA Hazard Rating Legend
* = Chronic Health Hazard
0 = INSIGNIFICANT
1 = SLIGHT
2 = MODERATE
3 = HIGH

National Fire Protection Association (NFPA)

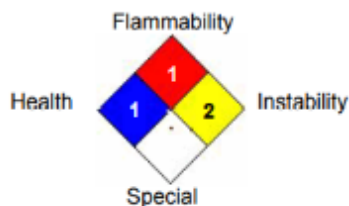

Date revised: 2017-02-02
Date Prepared: 4/18/2018

Reviewer Revision

SDS SHEETS - DUAL COAT CATALYST (EUROPE)



SAFETY DATA SHEET

Trade name: DUAL COAT CATALYST

According to Regulation (EC)
No 1907/2006 and
Regulation (EU) 2020/878

Date of print: 02/11/2023
Date of issue: 05/11/2020
Version: 1.0 / EN

SECTION 1: Identification of the substance/mixture and of the company/undertaking

1.1. Product identifier

Product name: DUAL COAT CATALYST / PICOTE DUAL COLOUR EPOXY FOR PICOTE BRUSH COATING™

Product code: PICOTE DC1000 E CATALYST / 2110001005

1.2. Relevant identified uses of the substance or mixture and uses advised against

„B“ component (amine) of two-component epoxy resin.

1.3. Details of the supplier of the safety data sheet

Producer/Supplier:

PICOTE SOLUTIONS OY LTD

Street/POB:

PIENTEOLLISUUSTIE 24

Postcode/City/Country:

06450 PORVOO, FINLAND

**E-mail address for a competent person
responsible for the safety data sheet:**

richard@picotesolutions.com

Phone:

+44 7827 223237

1.4. Emergency telephone number

Regional Medicines and Poisons Information Centre NI, Belfast

Tel.: +44 844 892 0111 (24 hrs)

SECTION 2: Hazards identification

2.1. Classification of the substance or mixture

Classification according to Regulation (EC) No 1272/2008 (CLP)

Hazard classes / categories	Hazard statements
Skin Corr. 1A	H314 Causes severe skin burns and eye damage.
Skin Sens. 1	H317 May cause an allergic skin reaction.
Eye Dam. 1	H318 Causes serious eye damage.
Repr. 2	H361f Suspected of damaging fertility.
Aquatic Acute 1	H400 Very toxic to aquatic life
Aquatic Chronic 1	H410 Very toxic to aquatic life with long-lasting effects.

2.2. Label elements

Labelling according to Regulation (EC) No 1272/2008 (CLP)

Hazard pictograms:



Signal word: Danger

Hazard statements:

H314 Causes severe skin burns and eye damage.
H317 May cause an allergic skin reaction.
H361f Suspected of damaging fertility.
H410 Very toxic to aquatic life with long-lasting effects.

EUH071 Corrosive to the respiratory tract

Precautionary statements:

P260 Do not breathe dust/fume/gas/mist/vapours/spray.
P280 Wear protective gloves/protective clothing/eye protection/face protection.

SDS SHEETS - DUAL COAT CATALYST (EUROPE)



SAFETY DATA SHEET

Trade name: DUAL COAT CATALYST

According to Regulation (EC)
No 1907/2006 and
Regulation (EU) 2020/878

Date of print: 02/11/2023
Date of issue: 05/11/2020
Version: 1.0 / EN

P301 + P330 + P331 IF SWALLOWED: Rinse mouth. Do NOT induce vomiting.
P303 + P361 + P353 IF ON SKIN (or hair): Take off immediately all contaminated clothing. Rinse skin with water/shower.
P305 + P351 + P338 IF IN EYES: Rinse cautiously with water for several minutes. Remove contact lenses if present and easy to do. Continue rinsing.
P304 + P340 IF INHALED: Remove person to fresh air and keep comfortable for breathing.
P273 Avoid release to the environment.

Hazard determining component(s) for labelling:

Contains: Reaction products of C18 (unsaturated) fatty acids with tetraethylenepentamine, 4-tert.-butylphenol, m-phenylenebis(methylamine), 2,2,4-trimethylhexane-1,6-diamine

2.3. Other hazards

The mixture does not meet the persistent (P), bioaccumulative (B) and toxic (T) criteria. The mixture is not PBT or vPvB.

SECTION 3: Composition/information on ingredients

3.2. Mixtures

Chemical characterization

Name	EC No. Index No.	CAS No.	REACH Reg. No.	Content (%)	Classification according to 1272/2008 (CLP)	
					Hazard categories ¹	H- phrase(s) ¹
Reaction products of C18 (unsaturated) fatty acids with tetraethylenepentamine	629-725-6 -	1226892-45-0	01-2119487006-38	<50%	Skin Corr. 1B Eye Dam. 1 Skin Sens. 1A Aquatic Acute 1 ³ Aquatic Chronic 1	H314 H318 H317 H400 H410
tert.-butylphenol ²	202-679-0 604-090-00-8	98-54-4	01-2119489419-21	<20%	Skin Irrit. 2 Eye Dam. 1 Repr. 2 Aquatic Chronic 1	H315 H318 H361f H410
m-phenylenebis(methylamine) ⁴	216-032-5 -	1477-55-0	01-2119514687-32	<20%	Acute Tox. 4 Acute Tox. 4 Skin Corr. 1B Eye Dam. 1 Skin Sens. 1B Aquatic Chronic 3	H302 H332 H314 H318 H317 H412
2,2,4-trimethylhexane-1,6-diamine	247-063-2 -	25513-64-8	01-2119480150-50	<10%	Acute Tox. 4 Skin Corr. 1B Eye Dam. 1 Skin Sens. 1 Aquatic Chronic 3	H302 H314 H318 H317 H412

¹ - See Section 16 for the full text of the abbreviations declared above.

² - Candidate list substance.

³ - M factor is 10

⁴ - EUH071 applies.

SDS SHEETS - DUAL COAT CATALYST (EUROPE)



SAFETY DATA SHEET

Trade name: DUAL COAT CATALYST

According to Regulation (EC)
No 1907/2006 and
Regulation (EU) 2020/878

Date of print: 02/11/2023
Date of issue: 05/11/2020
Version: 1.0 / EN

SECTION 4: First aid measures

4.1. Description of first aid measures

General advice:	In case of accident or if you feel unwell, seek medical advice immediately. Show the label where possible. Take off immediately all contaminated, soaked clothing. Wash thoroughly (shower or bath). The person concerned must be removed from the danger zone and laid down. He/she should be transported lying down, in a semi-sitting position in case of shortness of breath. He/she should be kept at rest, covered and kept warm. He/she must not be left unattended.
4.1.1. Inhalation:	The affected person should be taken out to fresh air and kept warm and calm. In case of respiratory distress or respiratory arrest give artificial respiration. Call a doctor immediately.
4.1.2. Skin contact:	If substance has got into skin, immediately wash out with plenty of soap and water. In case of skin reaction, consult a doctor. The injured person should receive medical treatment immediately because untreated chemical burns are difficult to heal. In case of skin irritation, consult a doctor.
4.1.3. Eye contact:	In case of contact with eyes, rinse immediately with plenty of running water for 10 to 15 minutes holding eyelids apart. Consult an eye doctor. Remove contact lenses, if present and easy to do. Continue rinsing. The intact eye must be protected.
4.1.4. Ingestion:	Rinse mouth with plenty of water (only if the person is conscious) and seek medical advice immediately. Do NOT induce vomiting.
Protection of first-aiders:	Take care of self-protection.

4.2. Most important symptoms and effects, both acute and delayed

In case of inhalation: irritation of the respiratory tract and lung.
In case of contact with skin: causes severe burns. May cause an allergic skin reaction.
On contact with eyes: causes serious eye damage.
On ingestion: causes severe internal burns. Gastrointestinal complaints. Abdominal pain. There is a risk of perforation of the esophagus and stomach (strong corrosive effect).

4.3. Indication of any immediate medical attention and special treatment needed

First aid, decontamination, symptomatic treatment. Follow-up for pneumonia and pulmonary edema.

SECTION 5: Firefighting measures

5.1. Extinguishing media

Suitable extinguishing media: carbon dioxide (CO₂), dry powder, alcohol resistant foam, water spray.
Unsuitable extinguishing media: high volume water jet.

5.2. Special hazards arising from the substance or mixture

In case of fire may be liberated: nitrogen oxides (NO_x), carbon monoxide (CO), carbon dioxide (CO₂), ammonia (NH₃).

5.3. Advice for firefighters

Promptly isolate the scene by removing all persons from the vicinity of the incident if there is a fire. No action shall be taken involving any personal risk or without suitable training.

Hazardous thermal decomposition products: Decomposition products may include the following substances: carbon dioxide, carbon monoxide, nitrogen oxides, ammonia.

Special protective equipment for firefighters: Firefighters should wear appropriate protective equipment and self-contained breathing apparatus (SCBA) with a full face-piece operated in positive pressure mode. Clothing for

SDS SHEETS - DUAL COAT CATALYST (EUROPE)



SAFETY DATA SHEET

Trade name: DUAL COAT CATALYST

According to Regulation (EC)
No 1907/2006 and
Regulation (EU) 2020/878

Date of print: 02/11/2023
Date of issue: 05/11/2020
Version: 1.0 / EN

firefighters (including helmets, protective boots and gloves) conforming to European standard EN 469 will provide a basic level of protection for chemical incidents.

SECTION 6: Accidental release measures

6.1. Personal precautions, protective equipment and emergency procedures

6.1.1. For non-emergency personnel: No action shall be taken involving any personal risk or without suitable training. Evacuate surrounding areas. Keep unnecessary and unprotected personnel from entering. Do not touch or walk through spilt material. Do not breathe vapour or mist. Provide adequate ventilation. Wear appropriate respirator when ventilation is inadequate. Put on appropriate personal protective equipment.

6.1.2. For emergency responders: If specialised clothing is required to deal with the spillage, take note of any information in Section 8 on suitable and unsuitable materials.

6.2. Environmental precautions

Avoid dispersal of spilt material and runoff and contact with soil, waterways, drains and sewers. Inform the relevant authorities if the product has caused environmental pollution (sewers, waterways, soil or air).

6.3. Methods and material for containment and cleaning up

Stop leak if without risk. Move containers from spill area. Approach the release from upwind. Prevent entry into sewers, water courses, basements or confined areas. Contain and collect spillage with non-combustible, absorbent material e.g. sand, earth, vermiculite or diatomaceous earth and place in container for disposal according to local regulations (see Section 13). Dispose of via a licensed waste disposal contractor. Contaminated absorbent material may pose the same hazard as the spilt product.

6.4. Reference to other sections

See Section 1 for emergency contact information.

See Section 8 for information on appropriate personal protective equipment.

See Section 13 for additional waste treatment information.

SECTION 7: Handling and storage

7.1. Precautions for safe handling

Protective measures: Put on appropriate personal protective equipment (see Section 8). Do not get in eyes, on skin or on clothing. Do not breathe vapour or mist. Do not swallow. Avoid release to the environment. If during normal use the material presents a respiratory hazard, use only with adequate ventilation or wear appropriate respirator. Keep in the original container or an approved alternative made from a compatible material, kept tightly closed when not in use. Empty containers may retain product residue and can be hazardous.

Advice on general occupational hygiene: Eating, drinking and smoking should be prohibited in areas where this material is handled, stored and processed. Workers should wash hands and face before eating, drinking and smoking. Remove contaminated clothing and protective equipment before entering eating areas. See also Section 8 for additional information on hygiene measures.

7.2. Conditions for safe storage, including any incompatibilities

Keep away from heat and flame. Keep container closed. Use with adequate ventilation. Avoid exposure to heat, light, and air for prolonged periods of time. Eliminate all ignition materials and incompatible materials.

7.3. Specific end use(s)

For the relevant identified use(s) listed in Section 1 the advice mentioned in this Section 7 has to be observed.

SDS SHEETS - DUAL COAT CATALYST (EUROPE)



SAFETY DATA SHEET

Trade name: DUAL COAT CATALYST

According to Regulation (EC)
No 1907/2006 and
Regulation (EU) 2020/878

Date of print: 02/11/2023
Date of issue: 05/11/2020
Version: 1.0 / EN

SECTION 8: Exposure controls/personal protection

8.1. Control parameters

DNEL values

4-tert-butylphenol (CAS: 98-54-4)

Workers: long-term exposure, dermal

Limit value: 0.071 mg/kg/day

Workers: long-term exposure, inhalation

Limit value: 0.5 mg/m³

PNEC values

Reaction products of C18 (unsaturated) fatty acids with tetraethylenepentamine (CAS: 1226892-45-0)

PNEC freshwater: 0.0307 mg/l

PNEC sediment: 119.8 mg/kg dry weight

PNEC marine water: 0.00307 mg/l

PNEC soil: 9.44 mg/kg dry weight

8.2. Exposure controls

Appropriate engineering controls:

Provide good ventilation. If artificial air-exhaust or ventilation is not possible or not satisfactory, a protective mask should be worn. The application of technical measures and appropriate work procedures shall take precedence over the use of personal protective equipment.

Individual protection measures

Hygiene measures

Wash hands, forearms and face thoroughly after handling chemical products, before eating, smoking and using the lavatory and at the end of the working period. Wash contaminated clothing before reusing. Ensure that eyewash stations and safety showers are close to the workstation location.

Eye/face protection

Safety eyewear or mask complying with an approved standard should be used when a risk assessment indicates this is necessary to avoid exposure to liquid splashes, mists, gases or dusts. If danger of inhalation exists, wear full facepiece respirator.

Skin protection

Hand protection

Chemical-resistant, impervious gloves complying with an approved standard should be worn at all times when handling chemical products if a risk assessment indicates this is necessary. Use gloves approved to relevant standards e.g. EN 374 (Europe). Suitability and durability of a glove is dependent on usage, e.g. frequency and duration of contact, chemical resistance of glove material and dexterity of user. Always seek advice from glove suppliers.

Body protection

Personal protective equipment for the body should be selected based on the task being performed and the risks involved and should be approved by a specialist before handling this product.

Other skin protection

Appropriate footwear and any additional skin protection measures should be selected based on the task being performed and the risks involved and should be approved by a specialist before handling this product.

Respiratory protection

In case of inadequate ventilation wear respiratory protection. Respirator selection must be based on known or anticipated exposure levels, the hazards of the product and the safe working limits of the selected respirator.

Environmental exposure controls

Emissions from ventilation or work process equipment should be checked to ensure they comply with the requirements of environmental protection legislation. In some cases, fume scrubbers, filters or engineering modifications to the process equipment will be necessary to reduce emissions to acceptable levels.

SDS SHEETS - DUAL COAT CATALYST (EUROPE)



SAFETY DATA SHEET

Trade name: DUAL COAT CATALYST

According to Regulation (EC)
No 1907/2006 and
Regulation (EU) 2020/878

Date of print: 02/11/2023
Date of issue: 05/11/2020
Version: 1.0 / EN

SECTION 9: Physical and chemical properties

9.1. Information on basic physical and chemical properties

a) Appearance:	liquid
b) Color:	yellow to brown
c) Odor:	characteristic
d) Melting point/freezing point:	not defined (mixture)
e) Boiling point or initial boiling point and boiling range:	no data
f) Flammability	ignitable
g) Lower and upper explosion limit:	not applicable (mixture)
h) Flash point:	no data
i) Autoignition temperature:	not applicable (mixture)
j) Decomposition temperature:	not applicable (mixture)
k) pH:	alkaline
l) Kinematic viscosity:	3000-4000 cps at 25°C
m) Solubility:	soluble in water
n) Partition coefficient n-octanol/water (log value)	not applicable (mixture)
o) Vapor pressure:	no data
p) Density and/or relative density:	1,01 kg/dm ³ at room temperature
q) Relative vapor density:	not applicable (mixture)
r) Particle characteristics	not applicable (liquid)

9.2. Other data

No data.

SECTION 10: Stability and reactivity

10.1. Reactivity

No specific test data related to reactivity available for this product or its ingredients.

10.2. Chemical stability

Stable under normal storage conditions.

10.3. Possibility of hazardous reactions

Under normal conditions of storage and use, hazardous reactions will not occur.

10.4. Conditions to avoid

To avoid exothermic reactions, keep away from oxidizing reagents and highly acidic materials.

10.5. Incompatible materials

Acids.

10.6. Hazardous decomposition products

No hazardous decomposition products if stored and handled as prescribed/indicated.

SECTION 11: Toxicological information

No test data is available for the product.

11.1. Information on hazard classes as defined in Regulation (EC) No 1272/2008

11.1.1. Acute toxicity:

Not classified according to the components.

11.1.2. Irritation/Corrosion

SDS SHEETS - DUAL COAT CATALYST (EUROPE)



SAFETY DATA SHEET

Trade name: DUAL COAT CATALYST

According to Regulation (EC)
No 1907/2006 and
Regulation (EU) 2020/878

Date of print: 02/11/2023
Date of issue: 05/11/2020
Version: 1.0 / EN

Causes severe skin burns and eye damage. Corrosive: may be absorbed through the skin.

11.1.3. Sensitisation

May cause sensitization by skin contact.

11.1.4. Germ cell mutagenicity

No data.

11.1.5. Carcinogenicity

No data.

11.1.6. Reproductive toxicity

Classified because of 4-tert-butylphenol content.

11.1.7. STOT – single exposure

No components are classified.

11.1.8. STOT – repeated exposure

No components are classified.

11.1.9. Aspiration hazard

No components are classified.

11.1.10. Toxicokinetics

No data.

11.1.11. Genetic toxicity

No data.

11.2. Information on other hazards

No specific data available.

SECTION 12: Ecological information

No test data is available for the product.

12.1. Toxicity

Data for Reaction products of C18 (unsaturated) fatty acids with tetraethylenepentamine (CAS: 1226892-45-0)

LC50 freshwater fish short-term: 0.19 mg/L

EC50 freshwater invertebrates short-term: 0.18 mg/L

NOEC freshwater invertebrates long-term: 0.307 mg/L

EC50 freshwater algae: 0.6125 mg/L

EC50 microorganisms: 109.4 mg/L

12.2. Persistence and degradability

Components are readily biodegradable.

12.3. Bioaccumulative potential

No data.

12.4. Mobility in soil

No data.

12.5. Results of PBT and vPvB assessment

The substances do not meet the criteria for PBT or vPvB according to REACH Regulation (EC No 1907/2006), Annex XIII.

12.6. Endocrine disrupting properties

None of the components is assessed as endocrine disruptors.

12.7. Other adverse effects

No information available.

SDS SHEETS - DUAL COAT CATALYST (EUROPE)



SAFETY DATA SHEET

Trade name: DUAL COAT CATALYST

According to Regulation (EC)
No 1907/2006 and
Regulation (EU) 2020/878

Date of print: 02/11/2023
Date of issue: 05/11/2020
Version: 1.0 / EN

SECTION 13: Disposal considerations

13.1. Waste treatment methods

Disposal methods: The generation of waste should be avoided or minimised wherever possible. Significant quantities of waste product residues should not be disposed of via the foul sewer but processed in a suitable effluent treatment plant. Dispose of surplus and non-recyclable products via a licensed waste disposal contractor. Disposal of this product, solutions and any by-products should at all times comply with the requirements of environmental protection and waste disposal legislation and any regional local authority requirements.

Special precautions: This material and its container must be disposed of in a safe way. Care should be taken when handling emptied containers that have not been cleaned or rinsed out. Empty containers or liners may retain some product residues. Avoid dispersal of spill material and runoff and contact with soil, waterways, drains and sewers.

SECTION 14: Transport information

(ADR/RID/ADN, IMDG, IATA)

14.1. UN number or ID number UN2735

14.2. UN proper shipping name Polyamines, liquid, corrosive, n.o.s.
(Aliphatic Amine, Polyamidoamine)

14.3. Transport hazard class(es) 8

14.4. Packing group II

14.5. Environmental hazards Yes

14.6. Special precautions for users

ADR/RID/ADN	IMDG	IATA
Tunnel code: (E)	EmS: (F-A, S-B)	PAX 851; CAO 855

14.7. Maritime transport in bulk according to IMO instruments

Not applicable.

SECTION 15: Regulatory information

15.1. Safety, health and environmental regulations/legislation specific for the substance or mixture

The product is covered by the SEVESO III Directive (Directive 2012/18/EU) due to its environmental hazards.

15.2. Chemical safety assessment

Chemical safety assessment has not been carried out for the mixture.

SECTION 16: Other information

The information given corresponds with our actual knowledge and experience. This information is meant to describe our product in view of possible safety requirements. Classification of the mixture is based on the classification of components.

16.1. Indication of changes

This version is the first version of the datasheet.

16.2. Abbreviations and acronyms

CAS No.: Chemical Abstracts Service number

CLP: Regulation on Classification, Labelling and Packaging

SDS SHEETS - DUAL COAT CATALYST (EUROPE)



SAFETY DATA SHEET

Trade name: DUAL COAT CATALYST

According to Regulation (EC)
No 1907/2006 and
Regulation (EU) 2020/878

Date of print: 02/11/2023
Date of issue: 05/11/2020
Version: 1.0 / EN

DNEL: Derived no effect level
EC: European Commission
EC No.: EINECS and ELINCS number
EC50: Half maximal effective concentration
EINECS: European Inventory of Existing Commercial Chemical Substances
ELINCS: European List of Notified Chemical Substances
EU: European Union
LC50: Lethal concentration, 50%
PBT: Persistent, Bioaccumulative and Toxic
PNEC: Predicted no-effect concentration
REACH: The Registration, Evaluation, Authorisation and Restriction of Chemicals
STOT: Specific target organ toxicity
vPvB: Very Persistent and Very Bioaccumulative

16.3. Key literature references and sources for data

Safety data sheets, received from the raw materials suppliers.

16.4. Full text of abbreviations

H-Phrases

H302	Harmful if swallowed.
H314	Causes severe skin burns and eye damage.
H315	Causes skin irritation.
H317	May cause an allergic skin reaction.
H318	Causes serious eye damage.
H332	Harmful if inhaled.
H361f	Suspected of damaging fertility.
H400	Very toxic to aquatic life
H410	Very toxic to aquatic life with long-lasting effects.
H412	Harmful to aquatic life with long-lasting effects.

EUH071	Corrosive to the respiratory tract
--------	------------------------------------

P-Phrases

P260	Do not breathe dust/fumes/gas/mist/vapours/spray.
P280	Wear protective gloves/protective clothing/eye protection/face protection.
P301 + P330 + P331	IF SWALLOWED: Rinse mouth. Do NOT induce vomiting.
P303 + P361 + P353	IF ON SKIN (or hair): Take off immediately all contaminated clothing. Rinse skin with water/shower.
P305 + P351 + P338	IF IN EYES: Rinse cautiously with water for several minutes. Remove contact lenses if present and easy to do. Continue rinsing.
P304 + P340	IF INHALED: Remove person to fresh air and keep comfortable for breathing.
P273	Avoid release to the environment.

Hazard classes

Acute Tox.	Acute toxicity
Aquatic Acute	Hazardous to the aquatic environment, acute
Aquatic Chronic	Hazardous to the aquatic environment, chronic
Eye Dam.	Serious eye damage
Repr.	Reproductive toxicity
Skin Corr.	Skin corrosion
Skin Irrit.	Skin irritation
Skin Sens.	Skin sensitization

SDS SHEETS - DUAL COAT BASE (EUROPE)



SAFETY DATA SHEET

Trade name: DUAL COAT BASE

According to Regulation (EC)
No 1907/2006 and
Regulation (EU) 2020/878

Date of print: 02/11/2023
Date of issue: 05/11/2020
Version: 1.0 / EN

SECTION 1: Identification of the substance/mixture and of the company/undertaking

1.1. Product identifier

Product name: DUAL COAT BASE (White and Gray) / PICOTE DUAL COLOUR EPOXY FOR PICOTE BRUSH COATING™
Product code: PICOTE DC1000 E BASE / 2110001005

1.2. Relevant identified uses of the substance or mixture and uses advised against

„A“ component (epoxy) of two-component epoxy resin.

1.3. Details of the supplier of the safety data sheet

Producer/Supplier:

PICOTE SOLUTIONS OY LTD

Street/POB:

PIENTEOLLISUUSTIE 24

Postcode/City/Country:

06450 PORVOO, FINLAND

**E-mail address for a competent person
responsible for the safety data sheet:**

richard@picotesolutions.com

Phone:

+44 7827 223237

1.4. Emergency telephone number

Regional Medicines and Poisons Information Centre NI, Belfast

Tel.: +44 844 892 0111 (24 hrs)

SECTION 2: Hazards identification

2.1. Classification of the substance or mixture

Classification according to Regulation (EC) No 1272/2008 (CLP)

Hazard classes / categories	Hazard statements
Skin Irrit. 2	H315 Causes skin irritation.
Skin Sens. 1B	H317 May cause an allergic skin reaction.
Eye Irrit. 2	H319 Causes serious eye irritation.
Aquatic Chronic 2	H411 Toxic to aquatic life with long lasting effects.

2.2. Label elements

Labelling according to Regulation (EC) No 1272/2008 (CLP)

Hazard pictograms:



Signal word: Warning

Hazard statements:

H315

Causes skin irritation.

H317

May cause an allergic skin reaction.

H319

Causes serious eye irritation.

H411

Toxic to aquatic life with long lasting effects.

EUH211

Warning! Hazardous respirable droplets may be formed when sprayed. Do not breathe spray or mist.

SDS SHEETS - DUAL COAT BASE (EUROPE)



SAFETY DATA SHEET

Trade name: DUAL COAT BASE

According to Regulation (EC)
No 1907/2006 and
Regulation (EU) 2020/878

Date of print: 02/11/2023
Date of issue: 05/11/2020
Version: 1.0 / EN

Precautionary statements:

P261 Avoid breathing dust/fumes/gas/mist/vapours/spray.
P273 Avoid release to the environment.
P280 Wear protective gloves/protective clothing/eye protection/face protection.
P333 + P313 If skin irritation or a rash occurs: Get medical advice/attention.
P305 + P351 + P338 IF IN EYES: Rinse cautiously with water for several minutes. Remove contact lenses if present and easy to do. Continue rinsing.
P391 Collect spillage.

Hazard determining component(s) for labelling:

Contains 2,2'-[(1-methylethylidene)bis(4,1-phenyleneoxymethylene)]bisoxirane;
Oxirane, mono[(C12-14-alkyloxy)methyl] derivs.

2.3. Other hazards

The mixture does not meet the persistent (P), bioaccumulative (B) and toxic (T) criteria. The mixture is not PBT or vPvB.

SECTION 3: Composition/information on ingredients

3.2. Mixtures

Chemical characterization: epoxy compounds with not disclosed, inert, non-hazardous filling materials.

Name	EC No. Index No.	CAS No.	REACH Reg. No.	Content (%)	Classification according to 1272/2008 (CLP)	
					Hazard categories ¹	H- phrase(s) ¹
2,2'-[(1-methylethylidene)bis(4,1-phenyleneoxy)methylene]] bisoxirane	216-823-5 603-074-00-8	1675-54-3	01-2119456619-26	<70	Skin Irrit. 2 Eye Irrit. 2 Skin Sens. 1 Aquatic Chronic 2	H315 H319 H317 H411
Titanium dioxide	236-675-5 022-006-00-2	13463-67-7	01-2119489379-17	<20	Carc. 2 ²	H332
Oxirane, mono[(C12-14-alkyloxy)methyl] derivs.	271-846-8 603-103-00-4	68609-97-2	01-2119485289-22	<10	Skin Irrit. 2 Skin Sens. 1	H315 H317

¹ - See Section 16 for the full text of the abbreviations declared above.

² - The Note 10 of the 14th ATP of CLP regulation was applied: The classification as a carcinogen by inhalation applies only to mixtures in powder form containing 1 % or more of titanium dioxide which is in the form of or incorporated in particles with aerodynamic diameter ≤ 10 µm.

SECTION 4: First aid measures

4.1. Description of first aid measures

General advice: In case of accident or if you feel unwell, seek medical advice immediately. Show the label where possible. Take off immediately all

contaminated, soaked clothing. Wash thoroughly (shower or bath). The person concerned must be removed from the danger zone and laid down. He/she should be transported lying down, in a semi-sitting position in case of shortness of breath. He/she should be kept at rest, covered and kept warm. He/she must not be left unattended.

4.1.1. Inhalation: The affected person should be taken out to fresh air and kept warm and calm. In case of respiratory distress or respiratory arrest give artificial respiration. Call a doctor immediately.

SDS SHEETS - DUAL COAT BASE (EUROPE)



SAFETY DATA SHEET

Trade name: DUAL COAT BASE

According to Regulation (EC)
No 1907/2006 and
Regulation (EU) 2020/878

Date of print: 02/11/2023
Date of issue: 05/11/2020
Version: 1.0 / EN

4.1.2. Skin contact:	If substance has got into skin, immediately wash out with plenty of soap and water. In case of skin reaction or irritation, consult a doctor.
4.1.3. Eye contact:	In case of contact with eyes, rinse immediately with plenty of running water for 10 to 15 minutes holding eyelids apart. Consult an eye doctor. Remove contact lenses, if present and easy to do. Continue rinsing. The intact eye must be protected.
4.1.4. Ingestion:	Rinse mouth with plenty of water (only if the person is conscious) and seek medical advice immediately. Do NOT induce vomiting.
Protection of first-aiders:	Take care of self-protection.

4.2. Most important symptoms and effects, both acute and delayed

Irritating to eyes and skin, sensitizing skin.

4.3. Indication of any immediate medical attention and special treatment needed

First aid, decontamination, symptomatic treatment.

SECTION 5: Firefighting measures

5.1. Extinguishing media

Suitable extinguishing media: carbon dioxide (CO₂), dry powder, alcohol resistant foam, water spray.

Unsuitable extinguishing media: high volume water jet.

5.2. Special hazards arising from the substance or mixture

In case of fire may be liberated: carbon monoxide (CO), carbon dioxide (CO₂), potentially hazardous substances produced in the fire.

5.3. Advice for firefighters

Promptly isolate the scene by removing all persons from the vicinity of the incident if there is a fire. No action shall be taken involving any personal risk or without suitable training.

Special protective equipment for fire-fighters:

Fire-fighters should wear appropriate protective equipment and self-contained breathing apparatus (SCBA) with a full face-piece operated in positive pressure mode. Clothing for fire-fighters (including helmets, protective boots and gloves) conforming to European standard EN 469 will provide a basic level of protection for chemical incidents.

SECTION 6: Accidental release measures

6.1. Personal precautions, protective equipment and emergency procedures

6.1.1. For non-emergency personnel: No action shall be taken involving any personal risk or without suitable training. Evacuate surrounding areas. Keep unnecessary and unprotected personnel from entering. Do not touch

or walk through spilt material. Do not breathe vapour or mist. Provide adequate ventilation. Wear appropriate respirator when ventilation is inadequate. Put on appropriate personal protective equipment.

6.1.2. For emergency responders: If specialized clothing is required to deal with the spillage, take note of any information in Section 8 on suitable and unsuitable materials.

6.2. Environmental precautions

Avoid dispersal of spilt material and runoff and contact with soil, waterways, drains and sewers. Inform the relevant authorities if the product has caused environmental pollution (sewers, waterways, soil or air).

6.3. Methods and material for containment and cleaning up

Stop leak if without risk. Move containers from spill area. Approach the release from upwind. Prevent entry into sewers, water courses, basements or confined areas. Contain and collect spillage with non-combustible, absorbent material e.g. sand, earth, vermiculite or diatomaceous earth and place in container for disposal according to local regulations

SDS SHEETS - DUAL COAT BASE (EUROPE)



SAFETY DATA SHEET

Trade name: DUAL COAT BASE

According to Regulation (EC)
No 1907/2006 and
Regulation (EU) 2020/878

Date of print: 02/11/2023
Date of issue: 05/11/2020
Version: 1.0 / EN

(see Section 13). Dispose of via a licensed waste disposal contractor. Contaminated absorbent material may pose the same hazard as the spill product.

6.4. Reference to other sections

See Section 1 for emergency contact information.
See Section 8 for information on appropriate personal protective equipment.
See Section 13 for additional waste treatment information.

SECTION 7: Handling and storage

7.1. Precautions for safe handling

Protective measures

It is recommended that all work processes be controlled so that no vapours or mists/aerosols can be inhaled. Put on appropriate personal protective equipment (see Section 8). Do not get in eyes, on skin or on clothing. Do not swallow. Avoid release to the environment. If local exhaust is not possible or not satisfactory, good ventilation of the entire work area should be provided if possible.

Advice on general occupational hygiene

Eating, drinking and smoking should be prohibited in areas where this material is handled, stored and processed. Workers should wash hands and face before eating, drinking and smoking. Remove contaminated clothing and protective equipment before entering eating areas. See also Section 8 for additional information on hygiene measures.

7.2. Conditions for safe storage, including any incompatibilities

Keep away from heat and flame. Keep container closed. Use with adequate ventilation. Avoid exposure to heat, light, and air for prolonged periods of time.

7.3. Specific end use(s)

For the relevant identified use(s) listed in Section 1 the advice mentioned in this Section 7 has to be observed.

SECTION 8: Exposure controls/personal protection

8.1. Control parameters

No exposure limit value is known in the EU directives.

DNEL values

2,2'-[(1-methylethylidene) bis(4,1-phenyleneoxymethylene)] bisoxirane (CAS: 1675-54-3)

Workers: systemic effects, acute exposure, dermal

Limit value: 8.3 mg/kg

Workers: systemic effects, long-term exposure, dermal

Limit value: 8.3 mg/kg

Workers: systemic effects, acute exposure, inhalation

Limit value: 12.3 mg/kg

Workers: systemic effects, long-term exposure, inhalation

Limit value: 12.3 mg/kg

PNEC values

2,2'-[(1-methylethylidene) bis(4,1-phenyleneoxymethylene)] bisoxirane (CAS: 1675-54-3)

PNEC freshwater: 0.006 mg/l

PNEC freshwater (intermittent releases): 0.018 mg/l

PNEC freshwater sediment: 0.996 mg/l

PNEC marine water: 0.0006 mg/l

PNEC marine sediment: 0.0996 mg/l

PNEC soil: 0.196 mg/l

PNEC sewage treatment plant: 10 mg/l

SDS SHEETS - DUAL COAT BASE (EUROPE)



SAFETY DATA SHEET

Trade name: DUAL COAT BASE

According to Regulation (EC)
No 1907/2006 and
Regulation (EU) 2020/878

Date of print: 02/11/2023
Date of issue: 05/11/2020
Version: 1.0 / EN

8.2. Exposure controls

Appropriate engineering controls:

Provide good ventilation. The application of technical measures and appropriate work procedures shall take precedence over the use of personal protective equipment.

Individual protection measures

Hygiene measures:

Avoid contact with skin, eyes and clothing. Wash hands, forearms and face thoroughly after handling chemical products, before eating, smoking, using the lavatory and at the end of the working period. Wash contaminated clothing before reusing. Ensure that eyewash stations and safety showers are close to the workstation location.

Eye/face protection:

Safety glasses with side shields (frame goggles, DIN EN 166). The eye shower should be kept ready and its location should be marked.

Skin protection

Hand protection:

Cuffed gloves. Suitable material: PVC (polyvinyl chloride), CR (polychloroprene, chloroprene rubber), butyl rubber, PVA (polyvinyl alcohol), FKM (fluoroelastomer), NBR (nitrile rubber). Wearing time in case of non-continuous contact (splashes): > 10 min. Only chemical protective gloves with a CE mark and a four-digit control number may be worn when working with chemicals. The breakthrough time and the swelling characteristics of the material must be taken into account. For special use, it is recommended to consult the glove manufacturer for the chemical resistance properties of each protective glove. DIN/EN standards: EN ISO 374.

Body protection:

Protective clothing: according to the standard DIN EN 14605.

Safety footwear: according to the standard DIN EN ISO 20345.

Respiratory protection:

Only wear protective clothing of the correct size, comfortable to wear and clean. No personal respirator is normally required. Wear a respirator only in case of exceeding limit values, insufficient ventilation or unsatisfactory operation of the exhaust fan.

Suitable respirator:

Respiratory protective device with combined filter (EN 14387), filter type: A. The class of the respirator must be adjusted to the highest concentration of pollutants (gas/vapor/aerosol/particles) that may be generated when working with the product. If the concentration is exceeded, self-contained breathing apparatus (SCBA) must be used. Use only SCBA with a CE mark and a four-digit control number.

SECTION 9: Physical and chemical properties

9.1. Information on basic physical and chemical properties

- | | |
|--|--|
| a) Appearance: | liquid |
| b) Color: | white or gray |
| c) Odor: | characteristic |
| d) Melting point/freezing point: | not defined (mixture) |
| e) Boiling point or initial boiling point and boiling range: | 268 °C (at 1013 hPa)
(Oxirane, mono[(C12-14-alkyloxy)methyl] derivs.) |
| f) Flammability | ignitable |
| g) Lower and upper explosion limit: | not applicable (mixture) |
| h) Flash point: | 159 °C
(Oxirane, mono[(C12-14-alkyloxy)methyl] derivs.) |
| i) Autoignition temperature: | not applicable (mixture) |
| j) Decomposition temperature: | not applicable (mixture) |
| k) pH: | not measurable, reacts with water |
| l) Kinematic viscosity: | 9500-10500 cps at 25°C |
| m) Solubility: | slightly soluble in water |
| n) Partition coefficient n-octanol/water (log value) | not applicable (mixture) |
| o) Vapor pressure: | 0.02 Pa (20 °C) |

SDS SHEETS - DUAL COAT BASE (EUROPE)



SAFETY DATA SHEET

Trade name: DUAL COAT BASE

According to Regulation (EC)
No 1907/2006 and
Regulation (EU) 2020/878

Date of print: 02/11/2023
Date of issue: 05/11/2020
Version: 1.0 / EN

<p>p) Density and/or relative density: q) Relative vapor density: r) Particle characteristics</p>	<p>(Oxirane, mono[(C12-14-alkyloxy)methyl] derivs.) 1,7 kg/dm³ at room temperature not applicable (mixture) not applicable (liquid)</p>
--	--

9.2. Other information
No data.

SECTION 10: Stability and reactivity

10.1. Reactivity

Product reacts with amines, amides causing the substance curing, strong mineral acids, bases and strong oxidizing agents.

10.2. Chemical stability

The product is stable if stored and handled as prescribed/indicated. See Section 7.

10.3. Possibility of hazardous reactions

May produce violent reactions with bases and numerous organic substances including alcohols and amines, polymerizing and generating heat.

10.4. Conditions to avoid

Short-term exposure to temperature > 50 °C or long-term exposure at > 30 °C; direct sunlight and humidity.

10.5. Incompatible materials

Strong oxidizing agents, strong mineral acids, bases, amines, amides.

10.6. Hazardous decomposition products

No hazardous decomposition products if stored and handled as prescribed/indicated.

SECTION 11: Toxicological information

No test data is available for the product.

11.1. Information on hazard classes as defined in Regulation (EC) No 1272/2008

11.1.1. Acute toxicity – oral

Endpoint	Species	Effective dose	Exposure route
(2,2'-[(1-methylethylidene)bis(4,1-phenyleneoxymethylene)]bisoxirane)			
LD50	Rat	> 15000 mg/kg	oral

Acute toxicity – dermal:

Endpoint	Species	Effective dose	Exposure route
(2,2'-[(1-methylethylidene)bis(4,1-phenyleneoxymethylene)]bisoxirane)			
LD50	Rabbit	23000 mg/kg	dermal

11.1.2. Irritation/Corrosion

Irritating to eyes and skin.

11.1.3. Sensitisation

May cause sensitization by skin contact because of two irritating components.

11.1.4. Germ cell mutagenicity

No components are classified.

11.1.5. Carcinogenicity

Titanium dioxide in powder form containing 1% or more of particles with aerodynamic diameter ≤ 10 µm is classified as Carc. 2 from 9 September 2021, but its liquid mixtures are not.

11.1.6. Reproductive toxicity

No components are classified.

11.1.7. STOT – single exposure

No components are classified.

11.1.8. STOT – repeated exposure

SDS SHEETS - DUAL COAT BASE (EUROPE)



SAFETY DATA SHEET

Trade name: DUAL COAT BASE

According to Regulation (EC)
No 1907/2006 and
Regulation (EU) 2020/878

Date of print: 02/11/2023
Date of issue: 05/11/2020
Version: 1.0 / EN

No components are classified.
11.1.9. Aspiration hazard
No components are classified.
11.1.10. Toxicokinetics
No data.
11.1.11. Genetic toxicity
No components are classified.

11.2. Information on other hazards

No specific data available.

SECTION 12: Ecological information

No test data is available for the product.

12.1. Toxicity

Aquatic toxicity to fish:

Endpoint	Species	Effective dose	Exposure
LC50	<i>Oncorhynchus mykiss</i> (rainbow trout)	2 mg/l	96 h

Acute aquatic toxicity to crustacea:

Endpoint	Species	Effective dose	Exposure
EC50	<i>Daphnia magna</i> (big water flea)	1.8 mg/l	48 h

Chronic aquatic toxicity to crustacea:

Endpoint	Species	Effective dose	Exposure
NOEC	<i>Daphnia magna</i> (big water flea)	0.55 mg/l	21 days

Acute aquatic toxicity to algae and cyanobacteria:

Endpoint	Species	Effective dose	Exposure
EC50	<i>Selenastrum capricornutum</i>	11 mg/l	72 h

Toxicity to microorganisms:

Endpoint	Species	Effective dose	Exposure
EC50	-	> 42.6 mg/l	8 h

12.2. Persistence and degradability

(2,2'-[(1-methylethylidene)bis(4,1-phenyleneoxymethylene)]bisoxirane)

Parameter: biodegradability

Duration: 28 days

Degradation rate: 12%

Not readily biodegradable

Method: OECD 302B

12.3. Bioaccumulative potential

(2,2'-[(1-methylethylidene)bis(4,1-phenyleneoxymethylene)]bisoxirane)

Parameter: bioconcentration factor

Value: 100-3000

Partition coefficient (n-octanol/water): 3.242

12.4. Mobility in soil

(2,2'-[(1-methylethylidene)bis(4,1-phenyleneoxymethylene)]bisoxirane)

Potential for mobility in soil is low (Koc = 500-2000)

SDS SHEETS - DUAL COAT BASE (EUROPE)



SAFETY DATA SHEET

Trade name: DUAL COAT BASE

According to Regulation (EC)
No 1907/2006 and
Regulation (EU) 2020/878

Date of print: 02/11/2023
Date of issue: 05/11/2020
Version: 1.0 / EN

12.5. Results of PBT and vPvB assessment

The substances do not meet the criteria for PBT or vPvB according to REACH Regulation (EC No 1907/2006), Annex XIII.

12.6. Endocrine disrupting properties

None of the components is assessed as endocrine disruptor.

12.7. Other adverse effects

No information available.

SECTION 13: Disposal considerations

13.1. Waste treatment methods

Disposal methods: The generation of waste should be avoided or minimized wherever possible. Significant quantities of waste product residues should not be disposed of via the foul sewer but processed in a suitable effluent treatment plant. Dispose of surplus and non-recyclable products via a licensed waste disposal contractor. Disposal of this product, solutions and any by-products should at all times comply with the requirements of environmental protection and waste disposal legislation and any regional local authority requirements.

Special precautions: This material and its container must be disposed of in a safe way. Care should be taken when handling emptied containers that have not been cleaned or rinsed out. Empty containers or liners may retain some product residues. Avoid dispersal of spilt material and runoff and contact with soil, waterways, drains and sewers.

SECTION 14: Transport information

(ADR/RID/ADN, IMDG, IATA)

14.1. UN number or ID number UN3082
14.2. UN proper shipping name Environmentally hazardous substance, liquid, n.o.s. (epoxy resin)
14.3. Transport hazard class(es) 9
14.4. Packing group III
14.5. Environmental hazards Yes
14.6. Special precautions for users

ADR/RID/ADN	IMDG	IATA
Tunnel code: (-)	EmS: (F-A, S-F)	PAX 964; CAO 964

14.7. Maritime transport in bulk according to IMO instruments

Not applicable.

SECTION 15: Regulatory information

15.1. Safety, health and environmental regulations/legislation specific for the substance or mixture

The product is covered by the SEVESO III Directive (Directive 2012/18/EU) due to its environmental hazards.

15.2. Chemical safety assessment

Chemical safety assessment has not been carried out for the mixture.

SDS SHEETS - DUAL COAT BASE (EUROPE)



SAFETY DATA SHEET

Trade name: DUAL COAT BASE

According to Regulation (EC)
No 1907/2006 and
Regulation (EU) 2020/878

Date of print: 02/11/2023
Date of issue: 05/11/2020
Version: 1.0 / EN

SECTION 16: Other information

The information given corresponds with our actual knowledge and experience. This information is meant to describe our product in view of possible safety requirements. Classification of the mixture is based on the classification of components.

16.1. Indication of changes

This is the first version of the datasheet.

16.2. Abbreviations and acronyms

CAS number: Chemical Abstracts Service number
CLP: Regulation on Classification, Labelling, Packaging
DNEL: Derived No Effect Level
EC: European Commission
EC number: EINECS and ELINCS number
EC50: Half maximal effective concentration
EINECS: European Inventory of Existing Commercial Chemical Substances

ELINCS: European List of Notified Chemical Substances

EU: European Union

Koc: Organic carbon – water partition coefficient (soil adsorption coefficient)

LC50: Lethal concentration, 50%

LD50: Median lethal dose

NOEC: No Observed Effect Concentration

OECD: Organisation for Economic Cooperation and Development

PBT: Persistent, Bioaccumulative and Toxic

PNEC: Predicted No Effect Concentration

REACH: The Registration, Evaluation, Authorisation and Restriction of Chemicals

STOT: Specific Target Organ Toxicity

vPvB: very Persistent and very Bioaccumulative

16.3. Key literature references and sources for data

Safety data sheets, received from the raw materials suppliers.

16.4. Full text of abbreviations

H-Phrases

H315	Causes skin irritation.
H317	May cause an allergic skin reaction.
H319	Causes serious eye irritation.
H332	Harmful if inhaled.
H411	Toxic to aquatic life with long lasting effects.

P-Phrases

P261	Avoid breathing dust/fumes/gas/mist/vapours/spray
P273	Avoid release to the environment.
P280	Wear protective gloves/protective clothing/eye protection/face protection.
P333 + P313	If skin irritation or a rash occurs: Get medical advice/attention.
P305 + P351 + P338	IF IN EYES: Rinse cautiously with water for several minutes. Remove contact lenses if present and easy to do. Continue rinsing.
P391	Collect spillage.

Hazard classes

Aquatic Chronic	Hazardous to the aquatic environment, chronic
Carc.	Carcinogenicity
Eye Irrit.	Serious eye irritation
Skin Irrit.	Skin irritation
Skin Sens.	Skin sensitization